

# Additional Units Kitchen Brochure 2017/18

Symphony®

If you contact Symphony's Additional Unit team then please provide the following information.

**PLOT NUMBER:** .....

**SITE CODE:** .....

(5 digit code available from your Builder, e.g. SY600)

**HOUSEBUILDER NAME:** .....

**SITE NAME:** .....

**SITE ADDRESS:** .....

**YOUR POSTCODE:** .....



Dibben Kitchens - [adunits@dibbenkitchens.co.uk](mailto:adunits@dibbenkitchens.co.uk) - 0800 8527780

# Designed with you in mind

The Symphony kitchen in your new home has been built to the highest standards by one of the country's largest and most respected manufacturers of quality fitted furniture.

Designed with flair and installed with the greatest attention to detail, we are confident you will be happy with its stylish appearance and durability for many years to come.

However, we're also sure that you'll want your new kitchen to reflect your particular tastes and lifestyle, whilst meeting all your individual requirements.

That's why we offer a wide choice of additional furniture, accessories and decorative features -

from wall or base units for extra space, through to glazed dressers to display your favourite possessions. In addition, there are alternative handles, internal storage, pull out wirework and decorative lighting to name a few options. Simply tell us your ideas and we'll help you create the kitchen you want. After all - you're unique, so your kitchen should be too.

Whilst you will discover a world of options in this brochure, these products form only a section of our full offer. To view our full portfolio please visit [www.symphony-group.co.uk](http://www.symphony-group.co.uk) or speak to our additional units team on 01226 446610. We wish you every success in your new home.



Call 01226 446610 or  
email [additionalunits@symphony-group.co.uk](mailto:additionalunits@symphony-group.co.uk)

All dimensions in the specification document are in millimetres.

# CONTENTS

IDENTIFY YOUR KITCHEN	6 - 21	PLINTHS	46, 52
CORNER UNITS	22 - 23	CORNICE AND PELMET	49 - 50
BASE UNITS	24 - 28	PILASTERS	48
WALL UNITS	29 - 33	CANOPIES	48
BOILER AND BASE APPLIANCE HOUSINGS	34	SPICE DRAWERS	51
LARDER AND PANTRY UNITS	35 - 37	GLASS SHELVING	53
OVEN HOUSINGS	38 - 41	UPSTANDS AND SPLASHBACKS	53
FRIDGE/FREEZER HOUSINGS	42 - 42	WORKTOPS AND ACCESSORIES	54
INTEGRATED APPLIANCE DOORS	43	ACCESSORIES	55 - 65
MID HEIGHT UNITS	44	CABINETS	66
WORKTOP DRESSER UNITS	45	FRONTALS	68
PANELS	46 - 49, 52	GENERAL INFORMATION	69 - 77

## HOW TO SPECIFY AND ORDER YOUR ADDITIONAL UNITS

Please browse through this brochure to identify the items that you would like to order. The checklist provided on the back page walks you through the ordering process to ensure you can give us all the information we require to provide you with your desired additional items to complete your kitchen.

Please note that the product range included in this brochure does not reflect our entire product offer.

To view the full offer please visit [www.symphony-group.co.uk](http://www.symphony-group.co.uk), or call our team on 01226 446610.



Our Additional Units team is on hand to ensure you can order your additions easily. Simply follow the steps below.



## IDENTIFYING YOUR KITCHEN UNITS

When planning your additional units please ensure you have the correct measurements. The following pages will assist you in identifying the information you require when ordering your additional kitchen units. Please use the fold out page at the back of the brochure as a checklist.



## REQUEST A QUOTE

When you are ready to request a quote or to discuss your order with us please contact us on **01226 446610** or email **additionalunits@symphony-group.co.uk**.

### IMPORTANT INFORMATION

Please ensure that you inform us of the following information about your property:

**PLOT NUMBER:** .....

**SITE CODE:** .....

(5 digit code available from your Builder, e.g. SY600)

**HOUSEBUILDER NAME:** .....

**SITE NAME:** .....

**SITE ADDRESS:** .....

**YOUR POSTCODE:** .....



## PLACE AN ORDER

All orders are processed by phone so when you are ready to place an order please contact us on **01226 446610**. We accept payment for your additional units order by either card or cheque.



## DELIVERY

Our standard delivery time is 3 weeks. Please note that you will need to arrange the fitting of your additional units as we offer these on a supply only basis and do not offer a fitting service.

Your additional units will be delivered to an address of your choice. You will need to arrange for an authorised person to be present at the time of delivery to sign for the order and provide access to your property. Our team will offload and take your additional units into the property. The majority of units are supplied in an assembled format, although certain units have to be supplied ready for assembly due to their size and/or construction. Please also note that to ensure the safe transit of assembled units some items may be supplied loose such as legs and handles.

**STEP 1** IDENTIFY YOUR CABINET

18mm Excel and 15mm Vista are the most popular cabinet specification in new homes. Please note this does not represent our entire product offer, to view the full portfolio please visit [www.symphony-group.co.uk](http://www.symphony-group.co.uk) or call our team on 01226 446610.

**15MM VISTA CABINETS** Internal cabinet finished in white with a choice of external cabinet colours



**18MM EXCEL CABINETS** Fully co-ordinated interior and exterior cabinet colours.



**STEP 2** IDENTIFY YOUR DRAWER

**SUPRA DRAWER BOX**

Colour: Cream  
 Cabinets: 15mm Vista and 18mm Excel  
 Soft close: optional upgrade



**REVO DRAWER BOX**

Colour: Grey  
 Cabinets: 18mm Excel only  
 Soft Close: As standard



**STEP 3** IDENTIFY YOUR HINGE

**110° STANDARD**



**110° SOFTPLUS**



**170° STANDARD**



**170° SOFTPLUS**



**STEP 4** IDENTIFY YOUR CABINET COLOUR

All our ranges are available with a choice of cabinet colours. Selected ranges offer frontal-matched replacement cabinet ends on 18mm cabinets (see Step 9). These allow you to create a fully co-ordinated kitchen that blends seamlessly into its surroundings.



IVORY



BLONDE OAK



WALNUT



WHITE

**STEP 5** → **IDENTIFY YOUR KITCHEN RANGE**

Identify or choose your range from our most popular kitchen choices shown below. Please note this does not represent our entire product offer, to view the full portfolio please visit [www.symphony-group.co.uk](http://www.symphony-group.co.uk), or call our team on 01226 446610.

**CONTEMPORARY DOORS**



**New York White**  
22mm gloss painted and lacquered MDF door

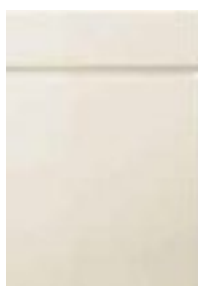

**New York Ivory**  
22mm gloss painted and lacquered MDF door



**New York Cashmere**  
22mm gloss painted and lacquered MDF door

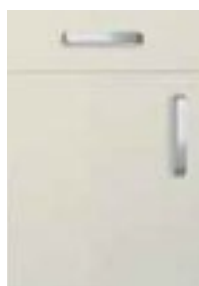

**Alta Mussel**  
18mm gloss painted and lacquered MDF door

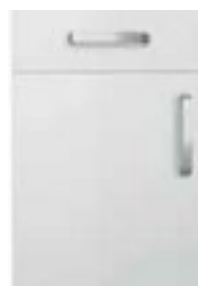

**Alta Pure White**  
18mm gloss painted and lacquered MDF door



**Orlando White**  
19mm Gloss painted door with glass edge effect

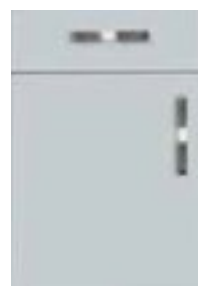

**Orlando Grey**  
19mm Gloss acrylic door with glass edge effect



**Orlando Dakar**  
19mm Gloss acrylic door with glass edge effect



**Westport White**  
19mm White laser edged matt painted MFC door

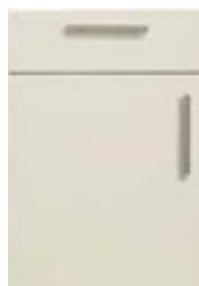

**Westport Ivory**  
19mm Ivory laser edged matt painted MFC door



**Woodbury Anthracite**  
18mm Gloss painted MFC

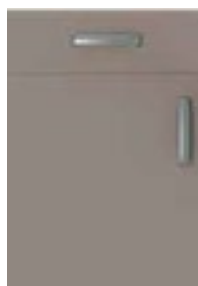

**Woodbury Basalt**  
18mm Gloss painted MFC

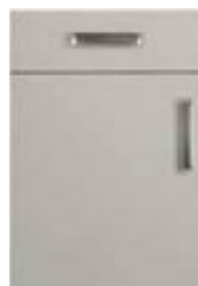

**Woodbury Cashmere**  
18mm Gloss painted MFC

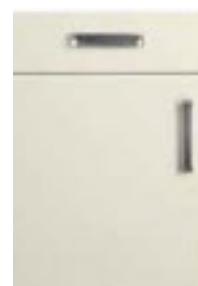

**Woodbury Ivory**  
18mm Gloss painted MFC

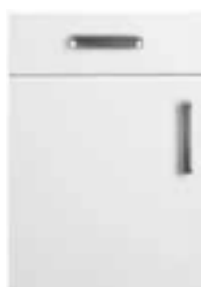

**Woodbury White**  
18mm Gloss painted MFC

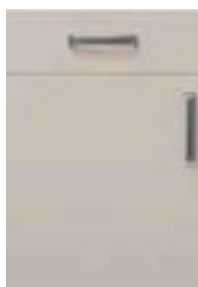

**Plaza Cashmere**  
18mm Cashmere MFC grained panel door with flat matching PVC edging

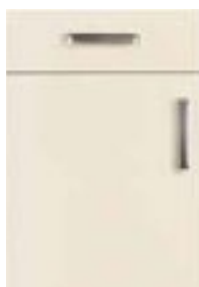

**Plaza Mussel**  
18mm Mussel MFC grained panel door with flat matching PVC edging

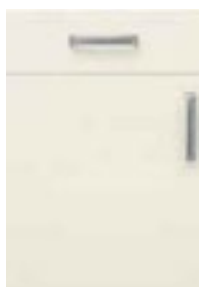

**Plaza Porcelain**  
18mm Porcelain MFC grained panel door with flat matching PVC edging



**Kansas**  
18mm Light Ash Cross-grain Textured MFC door with matching PVC edging



**Colorado**  
18mm Dark Oak Textured MFC door with matching PVC edging



**Plaza Stone**  
18mm Stone MFC grained panel door with flat matching PVC edging



**Minnesota**  
18mm Avola Grey Textured MFC door with matching PVC edging



**Hacienda White Ash**  
18mm flat panel MFC door with matching PVC edging

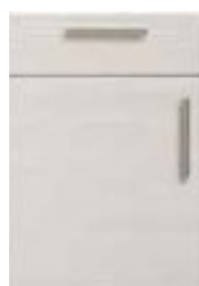

**Hacienda Ivory**  
18mm flat panel MFC door with matching PVC edging

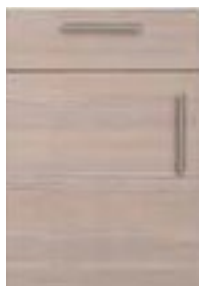

**Hacienda Champagne**  
18mm flat panel MFC door with matching PVC edging



**Medford**  
18mm Flat panel MFC door with white PVC edging



**Virginia Oak**  
18mm Oak effect MFC flat panel door with matching PVC edging



**Virginia Walnut**  
18mm Walnut effect MFC flat panel door with matching PVC edging



# IDENTIFY YOUR KITCHEN RANGE

## CLASSIC DOORS



**Austin**  
20mm Shaker style painted ivory door with ash veneered frame and centre panel



**Oakham**  
20mm Shaker style door with oak veneered frame and centre panel

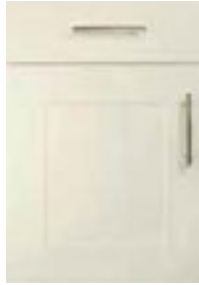

**Salerno Ivory**  
20mm MDF shaker style door with high gloss ivory PVC wrapped finish



**Salerno White**  
20mm MDF shaker style door with high gloss white PVC wrapped finish

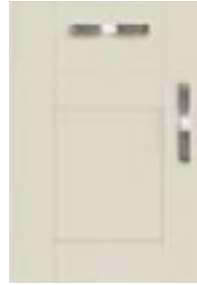

**Cranbrook Ivory**  
22mm Ivory foil wrapped MDF door in shaker style



**Cranbrook Platinum**  
22mm Platinum foil wrapped MDF door in shaker style



**Cranbrook Sage**  
22mm Sage foil wrapped MDF door in shaker style



**Cranbrook Stone**  
22mm Stone foil wrapped MDF door in shaker style



**Newport**  
18mm Ivory PVC wrapped door with tongue and grooved centre panel



**Calgary White**  
18mm White PVC wrapped door with tongue and grooved centre panel



**Georgia Oak**  
22mm Oak foil wrapped MDF door in shaker style

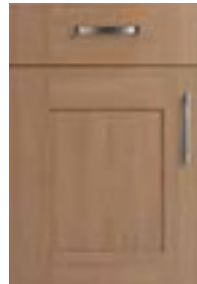

**Georgia Walnut**  
22mm Walnut foil wrapped MDF door in shaker style



**Oregon White**  
18mm White PVC wrapped saponetta edged door



**Oregon Cream**  
18mm Cream PVC foil wrapped saponetta edged door



**Oregon Dove Grey**  
18mm Grey PVC foil wrapped saponetta edged door

## GLAZED DOORS



**Alta** – frosted glass



**Austin** – clear



**Calgary** – clear



**Cranbrook** – clear



**Georgia** – textured



**Metallic effect framed door** – textured



**Newport** – plank effect frosted



**Oakham** – clear glass



**Salerno** – clear

# IDENTIFY YOUR KITCHEN RANGE

Inline kitchens present a modern linear style of kitchen design that features a stunning handle trim to the edge of doors and drawers. There is a choice of a brushed aluminium trim or a chrome wave trim.



Inline Chrome Wave Trim



Inline Aluminium Trim

## INLINE SELECT

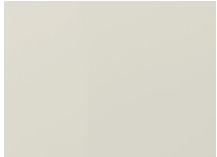

**Gloss Mussel**  
18mm gloss painted and lacquered MDF door

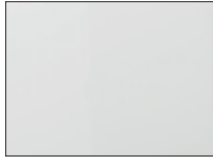

**Gloss Pure White**  
18mm gloss painted and lacquered MDF door

## INLINE TREND



**Gloss Diamond White**  
19mm Gloss painted door with glass edge effect



**Gloss Diamond Dakar**  
19mm Gloss acrylic door with glass edge effect



**Gloss Diamond Grey**  
19mm Gloss acrylic door with glass edge effect



**Matt Painted White**  
19mm White laser edged matt painted MFC door



**Matt Painted Ivory**  
19mm Ivory laser edged matt painted MFC door



**Gloss Ice Anthracite**  
18mm Gloss painted MFC door



**Gloss Ice Cashmere**  
18mm Gloss painted MFC door



**Gloss Ice Basalt** 18mm Gloss painted MFC door



**Gloss Ice Ivory**  
18mm Gloss painted MFC door

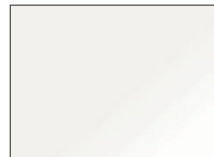

**Gloss Ice White**  
18mm Gloss painted MFC door

## INLINE FORM

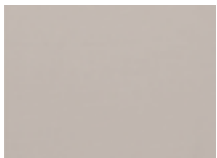

**Matt Cashmere Textured**  
18mm MFC grained panel door with flat matching PVC edging

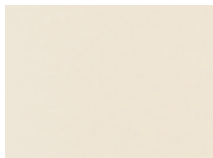

**Matt Mussel Textured**  
18mm MFC grained panel door with flat matching PVC edging

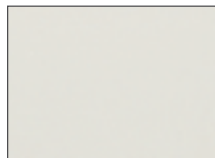

**Matt Porcelain Textured**  
18mm MFC grained panel door with flat matching PVC edging

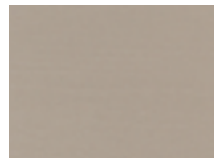

**Matt Stone Textured**  
18mm MFC grained panel door with flat matching PVC edging



**Matt Dark Oak Textured**  
18mm textured MFC door with matching PVC edging



**Matt Avola Grey Textured**  
18mm textured MFC door with matching PVC edging



**Matt Light Ash Textured**  
18mm cross-grain textured MFC door with matching PVC edging



**Matt Avola Champagne**  
18mm Flat panel MFC door with matching PVC edging

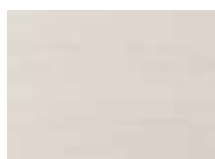

**Matt Avola Ivory**  
18mm flat panel MFC door with matching PVC edging



**Matt Avola White Ash**  
18mm flat panel MFC door with matching PVC edging



**Matt Oak**  
18mm MFC flat panel door with matching PVC edging



Identify or choose your handle from our most popular handle choices shown below.  
Please note this does not represent our entire product offer, to view the full portfolio please visit [www.symphony-group.co.uk](http://www.symphony-group.co.uk) or call our team on 01226 446610.

**Matt Nickel D Handle with Oval Feet**  
Handle Centres: 128mm



Code  
HPK226

**Matt Chrome Bridge Handle**  
Handle Centres: 128mm



Code  
HPK251

**188mm Matt Nickel Bar Handle**  
Handle Centres: 128mm



Code  
HPK275

**Matt Nickel Grooved Bar Handle**  
Handle Centres: 128mm



Code  
HPK279

**Matt Nickel Square D Handle**  
Handle Centres: 128mm



Code  
HPK296

**Matt Nickel Soft Formed**  
Handle Centres: 160mm



Code  
HPK331

**Matt Nickel Long Square D**  
Handle Centres: 192mm



Code  
HPK334

**Pewter Square D handle**  
Handle Centres: 128mm



Code  
HPK337

**Matt Nickel Chunky D handle**  
Handle Centres: 160mm



Code  
HPK354

**188mm Stainless steel chunky bar**  
Handle Centres: 128mm



Code  
HPK355

**Blonde Oak Knob**  
Handle Centres: Knob



Code  
HPK391

**Iron D handle**  
Handle Centres: 128mm



Code  
HPK404

**358mm Matt Nickel Bar Handle**  
Handle Centres: 160mm



Code  
HPK433

**Polished chrome D handle**  
Handle Centres: 160mm



Code  
HPK445

**Brushed nickel barrel D**  
Handle Centres: 160mm



Code  
HPK630

# IDENTIFY YOUR HANDLE

**Matt Brushed Nickel Arched**  
Handle Centres: 160, 192mm



Code  
HPK631

**Square Chrome Bar Handle**  
Handle Centres: 192mm



Code  
HPK634

**Chrome Chunky Bridge**  
Handle Centres: 160mm



Code  
HPK640

**Chrome Bow Handle**  
Handle Centres: 128mm



Code  
HPK641

**Chrome Square D Handle**  
Handle Centres: 128mm



Code  
HPK642

**Brushed Nickel Bow Handle.**  
Handle Centres: 160mm



Code  
HPK643

**Matt Nickel Square D Handle**  
Handle Centres: 160mm



Code  
HPK644

**Brushed Nickel Arched Handle**  
Handle Centres: 160mm



Code  
HPK645

**Matt Nickel Bow Handle**  
Handle Centres: 128mm



Code  
HPK647

**Matt Nickel Wide Bow Handle**  
Handle Centres: 160mm



Code  
HPK671

**Grooved Pewter D Handle**  
Handle Centres: 128mm



Code  
HPK672

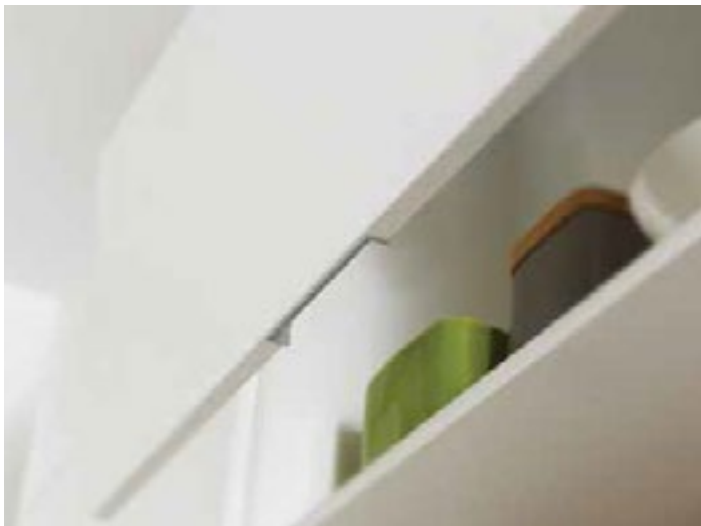

## INSET HANDLE WALL UNITS

The inset handle which is available in selected ranges can be added to all wall units, bifolds and bridging cupboards and is to be combined with standard handles on base units to create a subtle, more streamlined design option for the modern kitchen.

To choose this handle option add IN to the end of the wall cabinet code e.g. WU672IN.

### Inset Handle Range Availability

Alta	Colorado
Hacienda	Inline Form
Inline Select	Inline Trend
Kansas	Medford
Minnesota	Orlando
Plaza	Virginia
Westport	Woodbury

**STEP 7** → **SPECIFY YOUR UNIT SIZE** - BROWSE THROUGH THIS BROCHURE TO VIEW THE FULL UNIT CONTENT

**UNIT DIMENSIONS**

All dimensions are expressed as follows:

**WIDTH** - side to side  
**DEPTH** - front to back  
**HEIGHT** - top to bottom

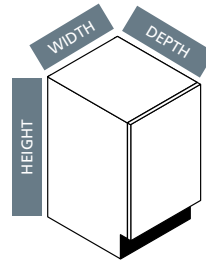

**2100mm Cabinet Elevations - Contemporary style example**

**NB:** Base cabinet height to underside of worktop is 870mm. Actual base cabinet depth is 470mm or 570mm (500mm or 600mm with worktop). Actual wall cabinet depth is 285mm.

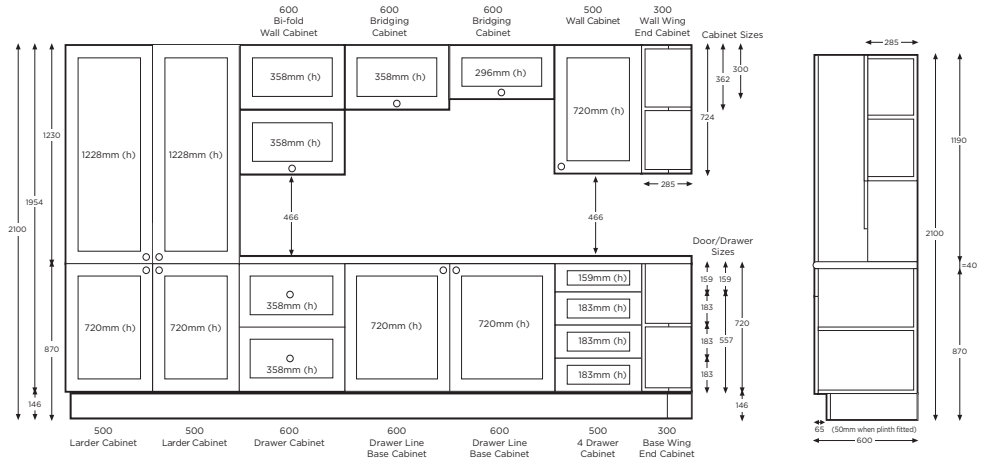

**2276mm Cabinet Elevations - Classic style example**

**NB:** Base cabinet height to underside of worktop is 870mm. Actual base cabinet depth is 570mm (600mm with worktop). Actual wall cabinet depth is 285mm.

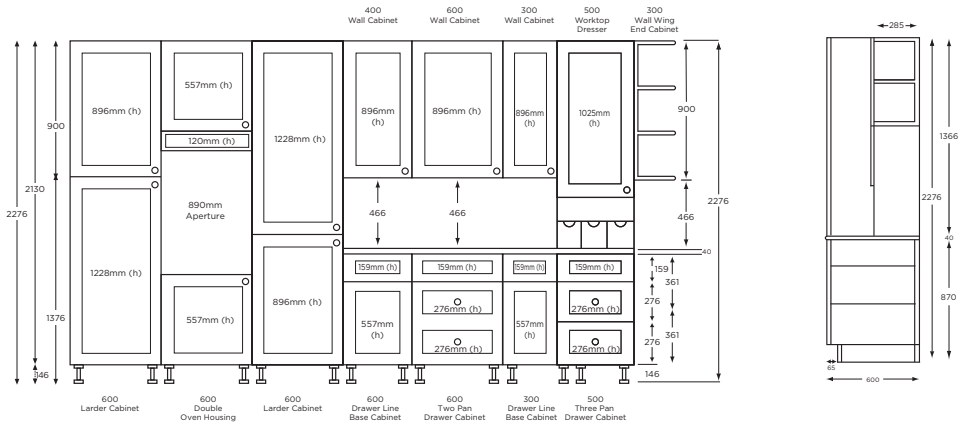

All dimensions are shown in millimetres

**STEP 8** → **IDENTIFY YOUR UNIT CODE**

**UNIT CODES**

**PREFIX LETTERS**

These indicate the type of unit, such as BU for base unit; WU for wall unit; BR for broom unit; LU for larder unit; OH for oven housing unit.

**NUMBERS**

The numbers indicate the width of the unit followed either by the depth, or in case of wall units, the height. For example a WU1056 is a wall unit 1000mm wide and 561mm high. A BU56 is a base unit 500mm wide and 600mm deep.

**SUFFIX LETTERS**

Any letters following the number code indicate a variant of the type as follows:

- A-K - variations of corner units or appliance housing formats
- F - Full height door base unit
- D - Drawer line base unit
- DD - Single base unit or corner base unit with a dummy drawer
- DAI - Double base unit with two dummy drawers
- DAC - Double base unit with one dummy drawer

- BO - Corner base unit with no corner post
- BS - Corner base unit with dummy drawer and no corner post
- GL - Unit with left hand replacement end
- GR - Unit with right hand replacement end
- G2 - Unit with two replacement ends
- IN - Inset Handle



(18MM CABINETS ONLY)



To enhance the finish of a selection of our kitchens, replacement cabinet end panels are available to order at an additional cost.

The replacement end panels are available on 18mm Excel cabinets only and are pre-fitted to the exposed ends of a unit run only. On base and tall units (for example larder units and tall appliance housings) the replacement cabinet end panel is a full length panel extending to the floor and therefore additional blender panels will not be required.

Please note: Worktop dressers, over cooker hoods, Belfast sink cabinets, bridging units for American fridge freezers, 1366mm and 1560mm high dresser boiler housings and reduced depth base cabinets are not available with replacement ends.

RANGE	DOOR COLOUR	INLINE RANGE	CABINET	REPLACEMENT END EXTERNAL COLOUR	REPLACEMENT END INTERNAL COLOUR	REPLACEMENT END GRAIN DIRECTION
Alta	Gloss Mussel	Select Gloss Mussel	Ivory	Gloss Mussel	Matt Mussel	N/A
Alta	Gloss Pure White	Select Gloss Pure White	White	Gloss Pure White	Matt Pure White	N/A
Boston	Gloss Ivory	N/A	Ivory	Gloss Ivory	Matt Ivory	N/A
Boston	Gloss White	N/A	White	Gloss White	Matt White	N/A
Colorado	Dark Oak	Form Matt Dark Oak Textured	White	Dark Oak	Dark Oak	Vertical
Cranbrook	Platinum	N/A	White	Platinum	Platinum	N/A
Cranbrook	Sage	N/A	Ivory	Sage	Sage	N/A
Cranbrook	Stone	N/A	Ivory	Stone	Stone	N/A
Hacienda	Champagne	Form Matt Avola Champagne	Ivory	Avola Champagne	Avola Champagne	Vertical
Hacienda	Ivory	Form Matt Avola Ivory	Ivory	Avola Ivory	Avola Ivory	Vertical
Hacienda	White Ash	Form Matt Avola White Ash	White	Avola White Ash	Avola White Ash	Vertical
Kansas	Light Ash	Form Matt Light Ash Textured	White	Light Ash	Light Ash	Horizontal
Minnesota	Avola Grey	Form Matt Avola Grey Textured	White	Avola Grey	Avola Grey	Vertical
New York	Gloss Cashmere	N/A	White	Gloss Cashmere	Matt Cashmere	N/A
New York	Gloss Ivory	N/A	White	Gloss Ivory	Matt Ivory	N/A
New York	Gloss White	N/A	White	Gloss White	Matt White	N/A
Orlando	Gloss Dakar	Trend Gloss Diamond Dakar	White	Gloss Dakar	Matt Dakar	N/A
Orlando	Gloss Grey	Trend Gloss Diamond Grey	White	Gloss Grey	Matt Grey	N/A
Orlando	Gloss White	Trend Gloss Diamond White	White	Gloss White	Matt White	N/A
Plaza	Cashmere	Form Matt Textured Cashmere	White	Textured Cashmere	Textured Cashmere	Vertical
Plaza	Mussel	Form Matt Textured Mussel	Ivory	Textured Mussel	Textured Mussel	Vertical
Plaza	Porcelain	Form Matt Textured Porcelain	White	Textured Porcelain	Textured Porcelain	Vertical
Plaza	Stone	Form Matt Textured Stone	Ivory	Textured Stone	Textured Stone	Vertical
Salerno	Gloss Ivory	N/A	Ivory	Gloss Ivory	Matt Ivory	N/A
Salerno	Gloss White	N/A	White	Gloss White	Matt White	N/A
Westport	Painted Ivory	Trend Matt Painted Ivory	Ivory	Painted Ivory	Painted Ivory	N/A
Westport	Painted White	Trend Matt Painted White	White	Painted White	Painted White	N/A
Woodbury	Gloss Anthracite	Trend Gloss Ice Anthracite	White	Gloss Anthracite	Matt Charcoal	N/A
Woodbury	Gloss Basalt	Trend Gloss Ice Basalt	White	Gloss Basalt	Matt Basalt	N/A
Woodbury	Gloss Cashmere	Trend Gloss Ice Cashmere	White	Gloss Cashmere	Matt Cashmere	N/A
Woodbury	Gloss Ivory	Trend Gloss Ice Ivory	Ivory	Gloss Ivory	Matt Ivory	N/A
Woodbury	Gloss White	Trend Gloss Ice White	White	Gloss White	Matt White	N/A

COLOUR OPTIONS



HOW TO ORDER

Simply add one of the following suffixes to the standard unit code:

- For a replacement cabinet end to the left hand side of a unit add **GL**. For example BU56F **GL** (See Fig.1)
- For a replacement cabinet end to the right hand side of a unit add **GR**. For example WU572 **GR** (see Fig.2)
- For replacement cabinet ends to both left and right hand sides of a unit add **G2**. For example LU56 **G2** (see Fig.3)

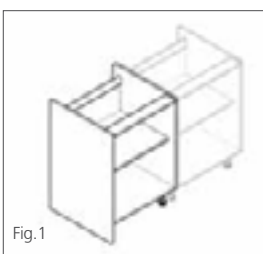

Fig.1

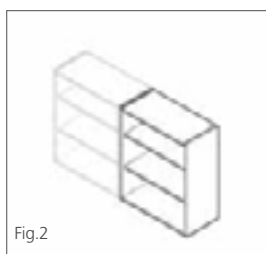

Fig.2

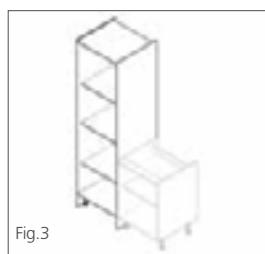

Fig.3

**STEP 10** → SPECIFY YOUR UNIT HANDING IF REQUIRED

## HANDINGS

Many units are described as left or right handed. Handings should be expressed as if looking at the unit from the front.

Handings required are:

- The side of the hinge on single units (e.g. left hand hinged)
- The side of the blanked end of corner units (e.g. left hand blanked)
- The position of the drainer on sink units (e.g. left hand drainer)
- The end position of a base wing end unit (e.g. left hand end)
- The side of a dummy drawer on a double base unit (e.g. left hand side)

**STEP 11** → REMEMBER TO ORDER PLINTHS AND ACCESSORIES

Specify any plinths and accessories such as cornice, pelmet, lighting, splashbacks and internal storage as required.

- |                      |                        |              |
|----------------------|------------------------|--------------|
| 1 LED Strip Lights   | 4 HD LED Square Lights | 7 Pelmet     |
| 2 Plinth Lights      | 5 Plinth               | 8 Upstand    |
| 3 HD LED Spot Lights | 6 Cornice              | 9 Splashback |



## REMEMBER TO ORDER ACCESSORIES

Many lights are available in a cool white or warm white light to provide flexibility to suit the design of the kitchen environment. Extra upgrade options like illuminated shelves or convenient pop up sockets within worktops are a perfect finishing touch to set a kitchen apart.

**sensio**<sup>®</sup>  
furniture lighting solutions



GX53 LED Round Light  
Can plug directly into mains.  
Available in a cool or warm white light.

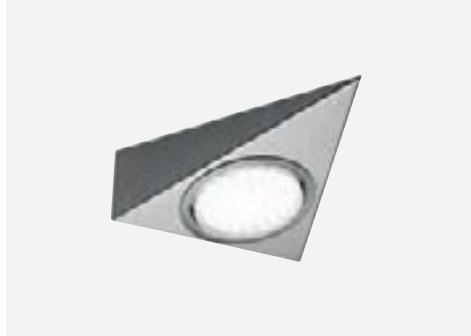

GX53 LED Triangle Light  
Can plug directly into mains.  
Available in a cool or warm white light.



HD Delta Light  
Available with optional on/off touch sensor.  
Available in a cool or warm white light.



Orbit Tilting Light  
Features tiltable centre section.  
Available in a cool or warm white light.

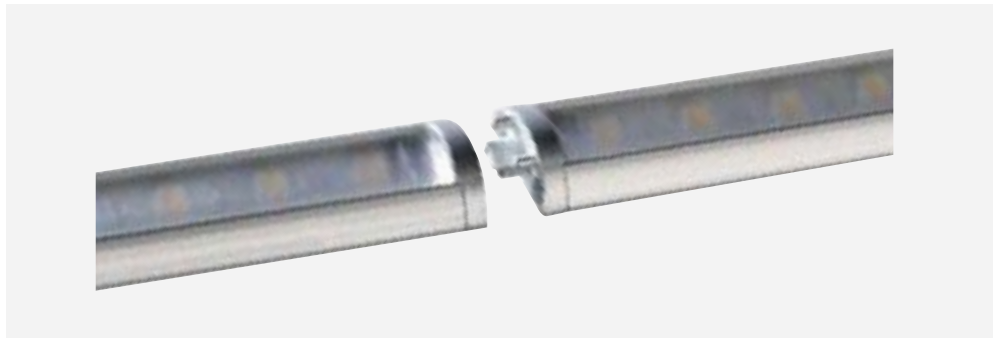

HD LED Linkable Strip Lights  
Linkable fittings to create a continuous run of lighting. Available in 400mm and 600mm lengths.

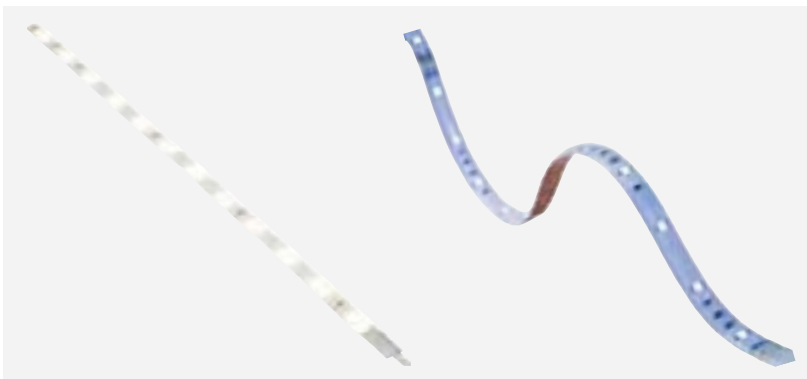

LED Flexible Strip Lights  
Available in 300mm or 2m lengths. Available in a cool white, warm white and blue light.



EVOLine(R) pop-up socket with USB ports featuring a flush finished Stainless Steel top  
POPUPSOCKUSS



Pop-up Socket with USB Ports  
POPUPSOCKU



# REMEMBER TO ORDER ACCESSORIES

A range of contemporary and subtle colours to suit any style of kitchen and complement our worktop selection.

## STANDARD COLLECTION

This collection features the four core splashback colours.



Bride



Chalk White



Ebony



Pewter



## GLOSS COLLECTION

Our Gloss Collection feature a diverse palette of colours that match and complement a variety of the kitchen finishes, accent open display units and include three metallic effect styles.

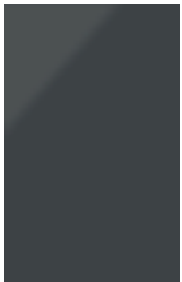

Anthracite



Blue



Bronze

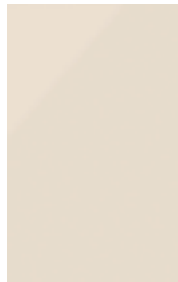

Cashmere



Dark Stone



Gold

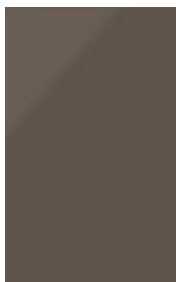

Lava

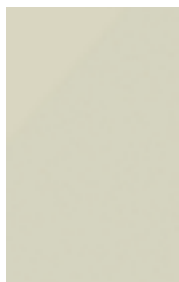

Light Stone



Midnight Stardust

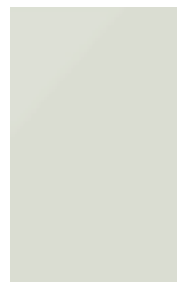

Platinum



Sage



Silver



White Sparkle



Yellow



## REMEMBER TO ORDER PLINTHS AND ACCESSORIES

Take advantage of every corner of the kitchen with innovative accessories and storage solutions that enhance every Konzept Kitchen.



Le Mans pull out (Left handed shown)



3/4 carousel baskets



Wine glass rack

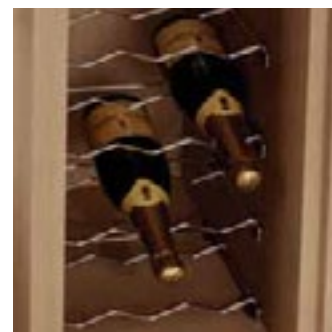

Wine rack insert



Stainless steel splashback



Angled Breakfast bar leg



Arrow Shelf Bracket



Chunky Floating Shelf



Removable Magnetic Lock



Larder Unit with internal drawers



Pan Drawer with Internal top drawer



Base Unit with internal drawers

# REMEMBER TO ORDER PLINTHS AND ACCESSORIES

## CUTLERY TRAYS



Supra Drawer Box Plastic Cutlery Tray



Revo Drawer Box Metallic Cutlery Tray



Aluminium Cutlery Tray



Luxury Beech Cutlery Tray

## ALUMINIUM PAN DRAWER ACCESSORIES



Orgflag Drawer Organiser



Aluminium Pan Drawer Organiser



Plate Stack



Orgawing

## WASTE STORAGE



Waste bin



Recycle bin



300mm eco bin



400mm eco bin



600mm eco bin

## 40MM LAMINATE WORKTOPS

Hard-wearing and stylish, our 40mm laminate worktops add the perfect finishing touch. Choose from a wide range of colours and designs, specifically developed to coordinate with the Konzept kitchen range. Worktops are supplied in a bullnose or PVC edged specification and are available with co-ordinating upstands, splashbacks and blenders.\*

\* maximum worktop length 4000mm



Alaska

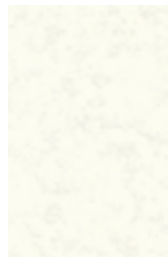

Alpine White

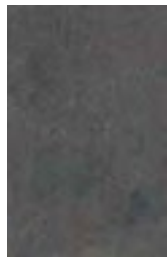

Copper Slate



Dark Ash



Everest Black



Natural Ash



Oak Block



Riverside Beige

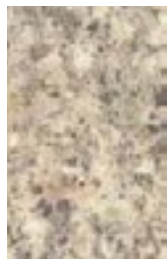

Riverside Beige



Riverside Grey



Sandstone



Stella Mare



Tectonica

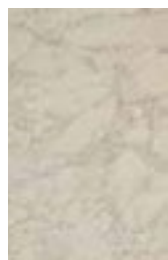

Turkish Marble



# IDENTIFY YOUR WORKTOP

## 40MM PREMIUM WORKTOPS

Our premium 40mm worktops feature either textured or ultra smooth laminate finishes with a contemporary 3mm front radius providing a modern flat profile.

Worktops are available with co-ordinating worktop upstands and splashbacks.\*

\*maximum worktop length 3600mm

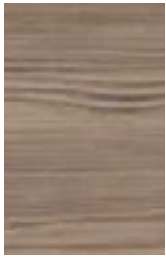

Cinnamon

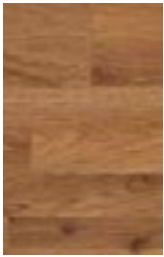

Colmar Oak

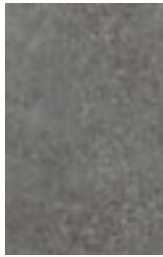

Empire Slate



Liberty Rock



Marble Brown

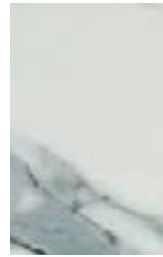

Marble Veneto



Woodstone



Volcanic Ash



## 22MM WORKTOP

These stunning 22mm worktops feature subtle textured surfaces and are the cutting edge of laminate worktop design. The colour palette includes finishes that match selected kitchen range decors to create an ultra modern one colour kitchen, or to provide another option for mix and match designs. Worktops are available with matching blenders, upstands and splashbacks.\*

\*maximum worktop length 3000mm



Brazillia

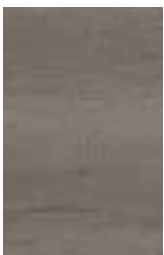

Dark Oak

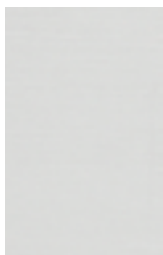

Designer White



Light Ash

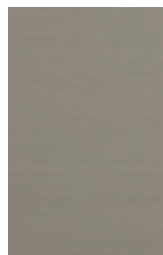

Matt Stone

# CORNER UNITS

All corner base units have centre hung doors with 110° hinges. Corner posts and blanking panels are fitted as standard. On corner base units with a corner post, a blanking panel covers the void of the unit.

A 600mm colour co-ordinated blanking panel is fitted where corner posts are NOT required - e.g. when the blank abuts a void for a freestanding appliance or tray space.

**IMPORTANT:** Please specify the handing of the side of the blanking panel when ordering.

Some of our corner base cabinets are available with a shelf or with a range of internal storage (not fitted). Storage options include Le Mans, ½ Carousel, or a Magic Corner.

Symphony's range of corner base units allows wide flexibility in the positioning of corner units for the clearance of water or soil vent pipes when required. Please specify the handing of the blanking panel side when ordering. For an explanation of handings see page 4.

## CORNER SINK BASE UNITS

1000mm corner base units can also be supplied as corner sink units. To specify a corner sink unit, change the prefix letters on the standard corner base unit code from 'CB' to 'CS' as shown in the example below.

Unit Code	Description
CS106DC	1000mm Corner Sink Base Cabinet, 600mm Door

## L SHAPE CORNER BASE UNIT

A corner unit with either a shelf or a revolving carousel. The two doors are hinged on the end panels and open to 170°. In order to facilitate transportation, the unit is supplied in two parts, one assembled and one ready for assembly (RFA) and the carousel or shelf must be fitted on site. Full height door or door and dummy drawer front styles are available. The dummy drawer fronts are fixed to the doors.

### 800mm Corner Base Cabinet

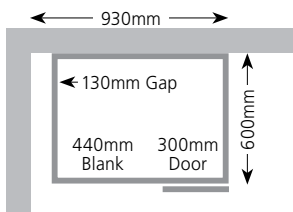

Full Height CB86FB  
Drawer Line CB86DB

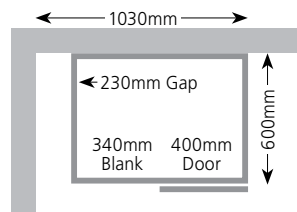

Full Height CB86FA  
Drawer Line CB86DA

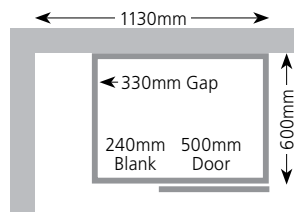

Full Height CB86FC  
Drawer Line CB86DC

### 900mm Corner Base Cabinet

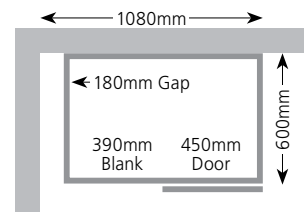

Full Height CB96FA  
Drawer Line CB96DA

### 1000mm Corner Base Cabinet

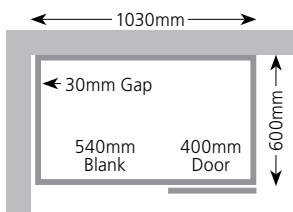

Full Height Door CB106FB  
Drawer Line CB106DB

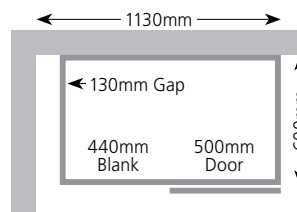

Full Height Door CB106FA  
Drawer Line CB106DA

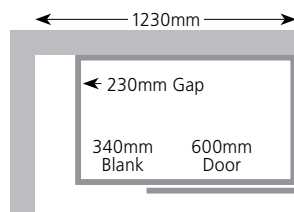

Full Height Door CB106FC  
Drawer Line CB106DC

### 1200mm Corner Base Cabinet

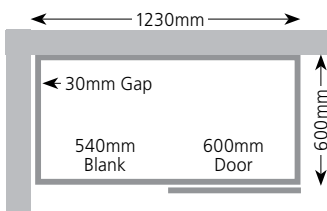

Full Height Door CB126FA  
Drawer Line CB126DA

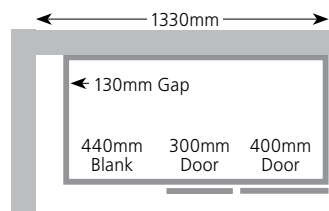

Full Height Door CB126FF  
Drawer Line CB126DF

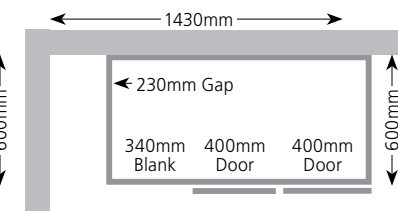

Full Height Door CB126FE  
Drawer Line CB126DE

### L Shaped Corner Base Cabinet

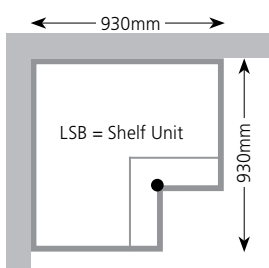

Full Height Door LSB99F  
Drawer Line LSB99D

### L Shaped Corner Base Cabinet with Carousel

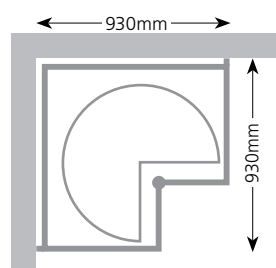

Full Height Door LCB99F  
Drawer Line LCB99D

## CORNER POST

The corner post allows product ranges with protruding handles to be offset by 30mm in order to avoid possible clashing of drawer handles in a corner. The corner post automatically spaces out the units to the correct size across Dimension A (on Corner Post diagram below). However the fitter must remember to position the corner unit (as appropriate) from the wall.

18mm corner posts co-ordinate with the frontal. 15mm corner posts co-ordinate with the cabinet colour.

## FRONTAL MATCHED FLEXIBLE CORNER UNITS

All standard corner base units are available with an optional flexible corner post instead of the normal corner post, to allow for adjustment of the position of return units in-situ. Flexible corner units are supplied with a fixed corner post panel (146mm), a fixed blanking panel and an adjustable corner post panel (42mm) which is supplied loose. All flexible corner units will coordinate with the kitchen frontal. To order the flexible corner post please add 'FP' to the current unit code where available.

To specify a flexible corner unit add a suffix to the standard unit code as shown below.

Variation	Suffix	Unit Code	Description
Flexible corner post	FP	CB106DCFP*	Corner base unit 1000 x 600 x 870. 600 door, flexible corner post

## CORNER WALL CABINET

Conventional corner wall cabinets should be positioned 30mm from the return cabinet. If a corner post is supplied, this is to space out the return cabinet to avoid the clashing of protruding handles.

## CORNER LARDER CABINET

Corner Larder Cabinets should be positioned 60mm from the return cabinet. The corner post, when fitted, will space out the cabinets to avoid the clash of handles. If the larder adjoins a base or wall cabinet, a full blanking panel (supplied) should be fitted.

### Corner Post

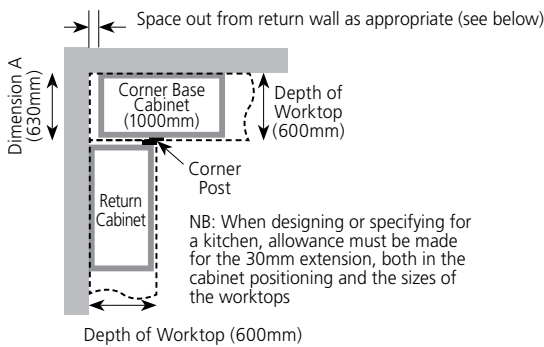

### Corner Larder Cabinet

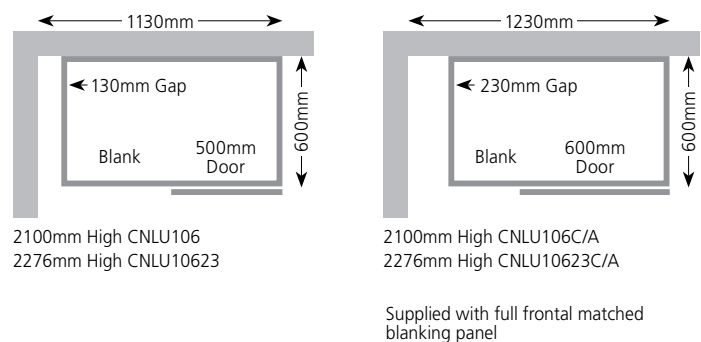

### 600mm Corner Wall Cabinet

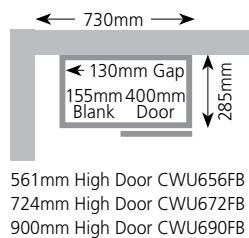
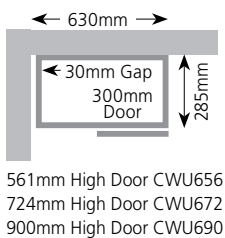

### 800mm Corner Wall Cabinet

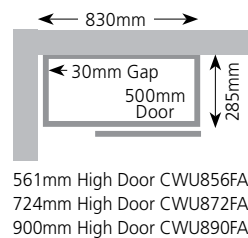

### 900mm Corner Wall Cabinet

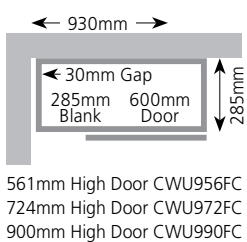

# CABINETS FULL HEIGHT DOOR BASE CABINETS

## Reduced Depth Single Base Cabinet

Height: 870mm  
Depth: 285mm  
Single adjustable shelf.  
Hand by hinge.  
150mm wide cabinets are 18mm Excel only.

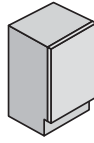

Width	Code
150mm	BU1503F
300mm	BU33F
400mm	BU43F
450mm	BU453F
500mm	BU53F
600mm	BU63F

## Reduced Depth Double Base Cabinet

Height: 870mm  
Depth: 285mm  
Single adjustable shelf.

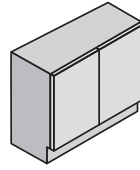

Width	Code
800mm	BU83F
900mm	BU93F
1000mm	BU103F

## Single Base Cabinet

Height: 870mm  
Depth: 570mm  
Single adjustable shelf.  
Hand by hinge.  
150mm wide cabinets are 18mm Excel only.

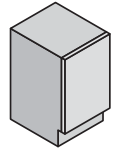

Width	Code
150mm	BU1506F
300mm	BU36F
400mm	BU46F
450mm	BU456F
500mm	BU56F
600mm	BU66F

## Single Base Cabinet with Pull Out Basket

Height: 870mm  
Depth: 570mm  
Chrome pull out basket to be fitted on-site.



Width	Code
150mm	BU1506BAF

## Double Base Cabinet

Height: 870mm  
Depth: 570mm  
Single adjustable shelf.

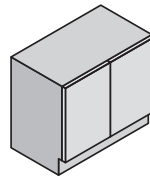

Width	Code
800mm	BU86F
900mm	BU96F
1000mm	BU106F
1200mm	BU126F

## Corner Cabinet

Height: 870mm  
Depth: 570mm  
Single adjustable shelf.  
Hand by blank, right hand blank shown.  
110° hinges  
Add 'FP' suffix for a frontal matched flexible corner post.

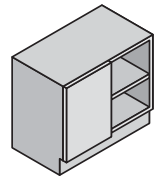

Width	Code
800mm 300 Door	CB86FB
800mm 400 Door	CB86FA
800mm 500 Door	CB86FC
900mm 450 Door	CB96FA

## Corner Cabinet

Height: 870mm  
Depth: 570mm  
Single adjustable shelf.  
Hand by blank, right hand blank shown.  
110° hinges  
Add 'FP' suffix for a frontal matched flexible corner post.

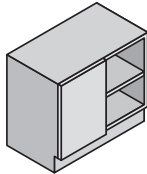

Width	Code
1000mm 400 Door	CB106FB
1000mm 500 Door	CB106FA
1000mm 600 Door	CB106FC
1200mm 600 Door	CB126FA

## Corner Cabinet

Height: 870mm  
Depth: 570mm  
Single adjustable shelf.  
Hand by blank, right hand blank shown.  
110° hinges  
Add 'FP' suffix for a frontal matched flexible corner post.

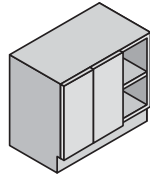

Width	Code
1200mm 300 and 400mm Doors	CB126FF
1200mm Two 400 Doors	CB126FE

## L Shaped Corner Cabinet

Height: 870mm  
Depth: 570mm  
Supplied in 2 parts, one part flatpack, one part assembled.  
Single adjustable shelf.  
LCB99F is supplied with chrome 3/4 carousel (CAROBASKCX) - to be fitted on-site.  
170° hinges

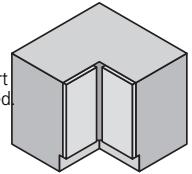

Width	Code
930x930mm	LSB99F
930x930mm with Carousel	LCB99F

## 45° Base Cabinet

Height: 870mm  
Depth: 570mm  
Single adjustable shelf.  
Hand by hinge, left hand cabinet shown.  
400mm door.  
For soft close doors order FPK903.  
Supplied RFA

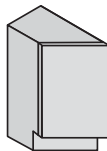

Width	Code
300mm	DBU36F45

## Flap Down Base Units

Height: 362mm  
Depth: 285mm  
To be wall hung.  
18mm Excel only.

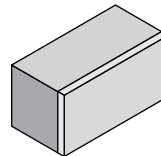

Width	Code
500mm	OCH536D
600mm	OCH636D
800mm	OCH836D
900mm	OCH936D
1000mm	OCH1036D



# CABINETS DRAWER LINE BASE CABINETS

## Reduced Depth Single Base Cabinet

Height: 870mm  
Depth: 285mm  
Dummy drawer.  
Single adjustable shelf.  
Hand by hinge.  
Not available in Inline.

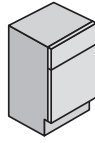

Width	Code
300mm	BU33D
400mm	BU43D
450mm	BU453D
500mm	BU53D
600mm	BU63D

## Double Reduced Depth Base Unit

Height: 870mm  
Depth: 285mm  
Two dummy drawers.  
Single adjustable shelf.  
Not available in Inline.

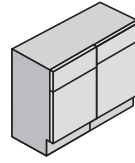

Width	Code
800mm	BU83D
900mm	BU93D
1000mm	BU103D

## Single Base Cabinet

Height: 870mm  
Depth: 570mm  
Single drawer.  
Single adjustable shelf.  
Hand by hinge.  
Not available in Inline.

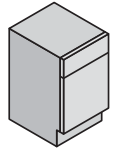

Width	Code
300mm	BU36D
400mm	BU46D
450mm	BU456D
500mm	BU56D
600mm	BU66D

## Double Base Cabinet

Height: 870mm  
Depth: 570mm  
Two drawers.  
Single adjustable shelf.  
Not available in Inline.

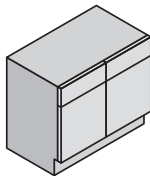

Width	Code
800mm	BU86D
900mm	BU96D
1000mm	BU106D
1200mm	BU126D

## Corner Cabinet

Height: 870mm  
Depth: 570mm  
Single drawer.  
Single adjustable shelf.  
Hand by blank, right hand blank shown.  
Not available in Inline.  
110° hinges  
Add 'FP' suffix for a frontal matched flexible corner post.

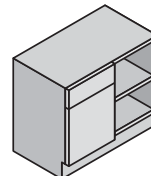

Width	Code
800mm 300 Door	CB86DB
800mm 400 Door	CB86DA
800mm 500 Door	CB86DC
900mm 450 Door	CB96DA

## Corner Cabinet

Height: 870mm  
Depth: 570mm  
Single drawer.  
Single adjustable shelf.  
Hand by blank, right hand blank shown.  
Not available in Inline.  
110° hinges  
Add 'FP' suffix for a frontal matched flexible corner post.

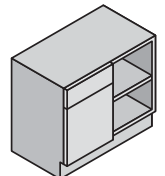

Width	Code
1000mm 400 Door	CB106DB
1000mm 500 Door	CB106DA
1000mm 600 Door	CB106DC
1200mm 600 Door	CB126DA

## Corner Cabinet

Height: 870mm  
Depth: 570mm  
Two drawers.  
Single adjustable shelf.  
Hand by blank, right hand blank shown.  
Not available in Inline.  
110° hinges  
Add 'FP' suffix for a frontal matched flexible corner post.

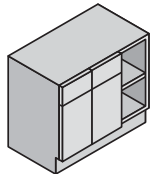

Width	Code
1200mm 300 and 400 Doors	CB126DF
1200mm Two 400 Doors	CB126DE

## L Shaped Corner Cabinet

Height: 870mm  
Depth: 570mm  
Two dummy drawers.  
Single adjustable shelf.  
Supplied in 2 parts, one part flatpack, one part assembled.  
LCB99D is supplied with chrome 3/4 carousel (CAROBASKCX) - to be fitted on-site.  
Not available in Inline.  
170° Hinges

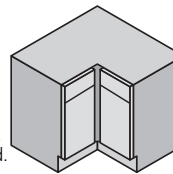

Width	Code
930x930mm	LSB99D
930x930mm with Carousel	LCB99D

## 45° Base Cabinet

Height: 870mm  
Depth: 570mm  
Dummy drawer.  
Hand by hinge, left hand cabinet shown.  
400mm door.  
Not available in Inline.  
Supplied RFA

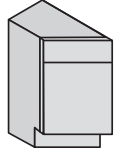

Width	Code
300mm	DBU36D45

# CABINETS SINK & HOB BASE CABINETS

## Single Full Height Sink Cabinet

Height: 870mm  
Depth: 570mm  
Supplied with Sink Liner.  
Single adjustable shelf.  
Hand by hinge.  
For full height sink units without sink liners order standard base unit codes.

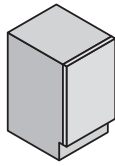

Width	Code
500mm	SU56SLF
600mm	SU66SLF

## Double Full Height Sink Cabinet

Height: 870mm  
Depth: 570mm  
Supplied with Sink Liner.  
Single adjustable shelf.  
For full height sink units without sink liners order standard base unit codes.

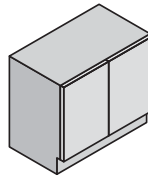

Width	Code
800mm	SU86SLF
900mm	SU96SLF
1000mm	SU106SLF
1200mm	SU126SLF

## Single Drawer Line Sink Cabinet

Height: 870mm  
Depth: 570mm  
With dummy drawer.  
Supplied with Sink Liner.  
Single adjustable shelf.  
Hand by hinge.  
Not available in Inline.

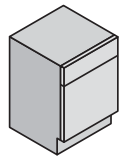

Width	Code
500mm	SU56SLD
600mm	SU66SLD

## Double Drawer Line Sink Cabinet

Height: 870mm  
Depth: 570mm  
With one dummy drawer.  
Supplied with Sink Liner.  
Hand by drainer i.e. left hand (LHD) supplied with right hand dummy drawer.  
Single adjustable shelf.  
Not available in Inline.

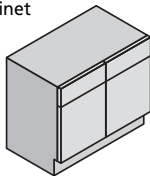

Width	Code
800mm	SU86SLD
900mm	SU96SLD
1000mm	SU106SLD
1200mm	SU126SLD

## Double Drawer Line Sink Cabinet

Height: 870mm  
Depth: 570mm  
With two dummy drawers.  
Supplied with Sink Liner.  
Single adjustable shelf.  
Not available in Inline.

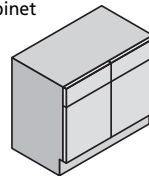

Width	Code
800mm	SU86SLDAI
900mm	SU96SLDAI
1000mm	SU106SLDAI
1200mm	SU126SLDAI

## Single Drawer Line Sink Cabinet

Height: 870mm  
Depth: 570mm  
With dummy drawer.  
Single adjustable shelf.  
Hand by hinge.  
Not available in Inline.

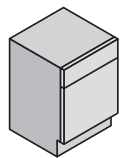

Width	Code
500mm	SU56DDD
600mm	SU66DDD

## Double Drawer Line Sink Cabinet

Height: 870mm  
Depth: 570mm  
With one dummy drawer.  
Hand by drainer i.e. left hand (LHD) supplied with right hand dummy drawer.  
Single adjustable shelf.  
Not available in Inline.

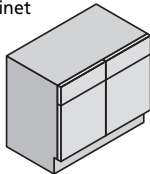

Width	Code
800mm	SU86D
900mm	SU96D
1000mm	SU106D
1200mm	SU126D

## Double Drawer Line Sink Cabinet

Height: 870mm  
Depth: 570mm  
With two dummy drawers.  
Single adjustable shelf.  
Not available in Inline.

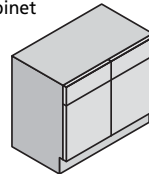

Width	Code
800mm	SU86DAI
900mm	SU96DAI
1000mm	SU106DAI
1200mm	SU126DAI

## Sink Cabinet Three Drawer

Height: 870mm  
Depth: 570mm  
With dummy top drawer and middle and bottom cut away drawers.  
Includes three sink baskets.  
Supplied with Revo drawer box. 18mm Excel cabinet only.  
Check sink depth. Maximum sink depth 220mm plus worktop thickness.

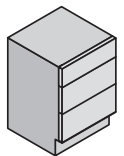

Width	Code
800mm	PD86D3SU3
900mm	PD96D3SU3
1000mm	PD106D3SU3

## Sink Cabinet Two Drawer

Height: 870mm  
Depth: 570mm  
With top and bottom cut away drawers.  
Includes three sink baskets.  
Supplied with Revo drawer box. 18mm Excel cabinet only.  
Check sink depth. Not compatible with undermount sinks.  
Maximum sink depth 140mm plus worktop thickness.

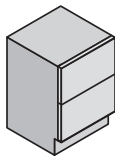

Width	Code
800mm	PD86D2SU2
900mm	PD96D2SU2

## Belfast Sink Cabinet

Height: 600mm  
Depth: 570mm  
Supplied with Sink Liner.  
Cabinet not compatible with laminate worktops.  
Supplied with 47mm fascia panel.  
Hand by hinge.  
Not available in Inline.

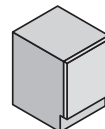

Width	Code
600mm	BSU66SLF

## Hob Cabinet

Height: 870mm  
Depth: 570mm  
With two dummy drawers.  
Single adjustable shelf.  
Not available in Inline.

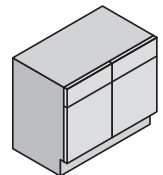

Width	Code
1000mm	HU106D

# CABINETS DRAWER BASE CABINETS

## Four Drawer Cabinet

Height: 870mm  
Depth: 570mm

With dummy top drawer and three deeper drawers.  
Not available in Inline.

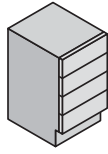

Width	Code
400mm	DU46DAQ
500mm	DU56DAQ
600mm	DU66DAQ

## Four Drawer Cabinet

Height: 870mm  
Depth: 570mm

With one shallow drawer and three deeper drawers.  
Not available in Inline.

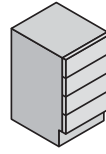

Width	Code
400mm	DU46D
500mm	DU56D
600mm	DU66D

## Full Height Door with 4 Internal Drawers

Height: 870mm  
Depth: 570mm  
With four Revo internal drawers.  
Full height door.  
Hand by hinge.

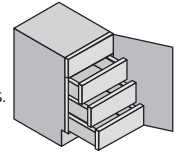

Suitable for cutlery trays 50mm smaller than the cabinet. Trays available for 450, 500 and 600 width cabinets, see p60 for details.  
The soft close buffer SMOVE1170 is supplied automatically for soft close doors to be used in place of the standard buffer.

Width	Code
300mm	BU36F4ID
400mm	BU46F4ID
450mm	BU456F4ID
500mm	BU56F4ID
600mm	BU66F4ID

## Full Height Door with 3 Deep Internal Drawers

Height: 870mm  
Depth: 570mm

With three Revo internal deep drawers.  
Full height door.

Hand by hinge.

The soft close buffer SMOVE1170 is supplied automatically for soft close doors to be used in place of the standard buffer.

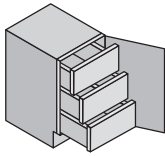

Width	Code
300mm	BU36F3ID
400mm	BU46F3ID
450mm	BU456F3ID
500mm	BU56F3ID
600mm	BU66F3ID

## Full Height Door with 1 Cutlery, 2 Deep Internal Drawers

Height: 870mm  
Depth: 570mm

With one Revo internal cutlery drawer and two Revo internal deep drawers.  
Full height door.

Hand by hinge.

The soft close buffer SMOVE1170 is supplied automatically for soft close doors to be used in place of the standard buffer.

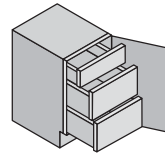

Width	Code
500mm	BU56F3IDC
600mm	BU66F3IDC

## Full Height Door with 1 Cutlery and 2 Deep Internal Drawers

Height: 870mm  
Depth: 570mm

Full height door.

Full height drawer frontal attached to a deep internal drawer, with one internal cutlery drawer and one deep internal drawer.

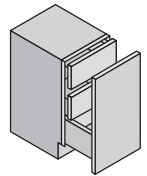

Width	Code
600mm	BU66F2ID

## Three Drawer Cabinet

Height: 870mm  
Depth: 570mm

With one shallow drawer and two pan drawers.

The drawers on 800, 900 and 1000 widths supplied with Revo drawer box. 18mm Excel cabinet only.

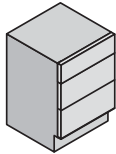

Width	Code
500mm	PD56D3
600mm	PD66D3
800mm	PD86D3
900mm	PD96D3
1000mm	PD106D3

## Two Drawer Cabinet

Height: 870mm  
Depth: 570mm

With two deep pan drawers.

800 and 900 widths supplied with Revo drawer box. 18mm Excel cabinet only.

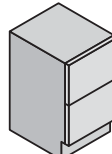

Width	Code
500mm	PD56D2
600mm	PD66D2
800mm	PD86D2
900mm	PD96D2

## Two Drawer Cabinet

Height: 870mm  
Depth: 570mm

With two deep pan drawers and internal top drawer.

800 and 900 widths supplied with Revo drawer box.

Supplied with Revo internal drawerbox

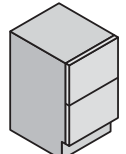

Width	Code
500mm	PD56D2IDT
600mm	PD66D2IDT
800mm	PD86D2IDT
900mm	PD96D2IDT

# CABINETS FEATURE BASE CABINETS

## Wicker Basket Cabinet

Height: 870mm  
 Depth: 570mm  
 Available in melamine cabinet colours.  
 18mm Excel cabinet only.  
 Not available in Inline.

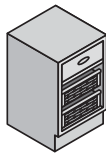

Width	Code
500mm	WBU56D

## Accent Base Open Display Units

Height: 870mm  
 Depth: 285mm  
 Available in 18mm MFC matt colours: Blue, Cashmere, Dark Oak, Stone and Yellow.

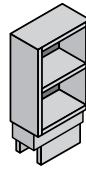

Width	Code
500mm	ODUB572AC
600mm	ODUB672AC

## Spice and Wine Rack Cabinet

Height: 870mm  
 Depth: 285mm  
 Four wine racks – holds up to 12 bottles.  
 Available in melamine cabinet colours.  
 18mm Excel cabinet only.  
 Not available in Inline.

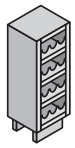

Width	Code
300mm Melamine	BWR3

## Spice and Wine Rack Cabinet

Height: 870mm  
 Depth: 285mm  
 Five wine slots.  
 Available in melamine cabinet colours.  
 18mm Excel cabinet only.  
 Not available in Inline.

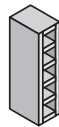

Width	Code
150mm Melamine	SPWR15

## Plate Rack Cabinet

Height: 870mm  
 Depth: 285mm  
 Available in melamine cabinet colours.  
 18mm Excel cabinet only.  
 Not available in Inline.



Width	Code
500mm Melamine	ODMB85

## Lattice Wine Rack Cabinet

Height: 870mm  
 Depth: 285mm  
 Available in melamine cabinet colours.  
 18mm Excel cabinet only.  
 Not available in Inline.

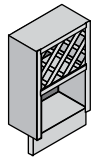

Width	Code
500mm Melamine	ODMB95

## Plate and Lattice Wine Rack Cabinet

Height: 870mm  
 Depth: 285mm  
 Available in melamine cabinet colours.  
 18mm Excel cabinet only.  
 Not available in Inline.

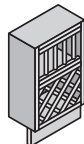

Width	Code
500mm Melamine	ODMB105

# CABINETS 561MM HIGH WALL CABINETS & FEATURE CABINETS

## Single 561mm Wall Cabinet

Height: 561mm  
Depth: 285mm  
One adjustable shelf.  
Hand by hinge.

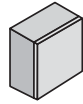

Width	Code
300mm	WU356
400mm	WU456
450mm	WU4556
500mm	WU556
600mm	WU656

## Single 561mm Wall Cabinet with Inset Handle

Height: 561mm  
Depth: 285mm  
One adjustable shelf.  
Hand by hinge.  
Available in selected Inline and Contemporary ranges only. See page 17.

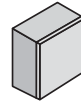

Width	Code
300mm	WU356IN
400mm	WU456IN
450mm	WU4556IN
500mm	WU556IN
600mm	WU656IN

## Double 561mm Wall Cabinet

Height: 561mm  
Depth: 285mm  
One adjustable shelf.

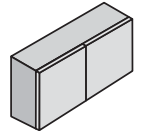

Width	Code
800mm	WU856
900mm	WU956
1000mm	WU1056

## Double 561mm Wall Cabinet with Inset Handle

Height: 561mm  
Depth: 285mm  
One adjustable shelf.  
Available in selected Inline and Contemporary ranges only. See page 17.

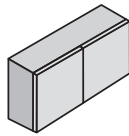

Width	Code
800mm	WU856IN
900mm	WU956IN
1000mm	WU1056IN

## Corner Wall Cabinet

Height: 561mm  
Depth: 285mm  
One adjustable shelf.  
Hand by blank, right hand blank shown.  
15mm cabinets are supplied with 170° hinges (for soft close doors order SOFTCL170) and 18mm cabinets with 110° hinges (for soft close doors order SMOVE1110).  
FP' suffix for a frontal matched flexible corner post.

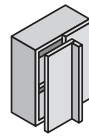

Width	Code
600mm 300 Door	CWU656
600mm 400 Door	CWU656FB
800mm 500 Door	CWU856FA
900mm 600 Door	CWU956FC

## Corner Wall Cabinet with Inset Handle

Height: 561mm  
Depth: 285mm  
One adjustable shelf.  
Hand by blank, right hand blank shown.  
15mm cabinets are supplied with 170° hinges (for soft close doors order SOFTCL170) and 18mm cabinets with 110° hinges (for soft close doors order SMOVE1110).  
FP' suffix for a frontal matched flexible corner post.

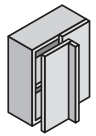

Width	Code
600mm 300 Door	CWU656IN
600mm 400 Door	CWU656INFB
800mm 500 Door	CWU856INFA
900mm 600 Door	CWU956INFC

## Open Wall Cabinet

Height: 561mm  
Depth: 285mm  
Single fixed shelf.  
Available in melamine cabinet colours.  
Not available in Inline.

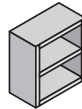

Width	Code
500mm Melamine	ODU556

## Accent Wall Open Display Units

Height: 561mm  
Depth: 285mm  
Available in 18mm MFC matt colours: Blue, Cashmere, Dark Oak, Stone and Yellow.

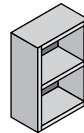

Width	Code
500mm	ODU556AC
500mm	ODU656AC

# CABINETS 724MM HIGH WALL CABINETS

## Single Wall Cabinet

Height: 724mm  
Depth: 285mm  
Single adjustable shelf (15mm Vista). Two adjustable shelves (18mm Excel).  
Hand by hinge.  
150mm wide cabinets are 18mm Excel only.

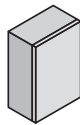

Width	Code
150mm	WU15072
300mm	WU372
400mm	WU472
450mm	WU4572
500mm	WU572
600mm	WU672

## Single Wall Cabinet with Inset Handle

Height: 724mm  
Depth: 285mm  
Single adjustable shelf (15mm Vista). Two adjustable shelves (18mm Excel).  
Hand by hinge.  
Available in selected Inline and Contemporary ranges only. See page 17.  
150mm wide cabinets are 18mm Excel only.

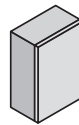

Width	Code
150mm	WU15072IN
300mm	WU372IN
400mm	WU472IN
450mm	WU4572IN
500mm	WU572IN
600mm	WU672IN

## Double Wall Cabinet

Height: 724mm  
Depth: 285mm  
Single adjustable shelf (15mm Vista). Two adjustable shelves (18mm Excel).

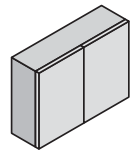

Width	Code
800mm	WU872
900mm	WU972
1000mm	WU1072

## Double Wall Cabinet with Inset Handle

Height: 724mm  
Depth: 285mm  
Single adjustable shelf (15mm Vista). Two adjustable shelves (18mm Excel).  
Available in selected Inline and Contemporary ranges only. See page 17.

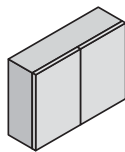

Width	Code
800mm	WU872IN
900mm	WU972IN
1000mm	WU1072IN

## Bi-fold Wall Cabinet

Height: 724mm  
Depth: 285mm  
Single adjustable shelf.  
18mm Excel cabinet only.

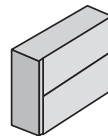

Width	Code
500mm	HFUW572
600mm	HFUW672
800mm	HFUW872
900mm	HFUW972

## Bi-fold Wall Cabinet with Inset Handle

Height: 724mm  
Depth: 285mm  
Single adjustable shelf.  
18mm Excel cabinet only.  
Available in selected Inline and Contemporary ranges only. See page 17.

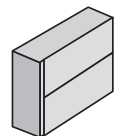

Width	Code
500mm	HFUW572IN
600mm	HFUW672IN
800mm	HFUW872IN
900mm	HFUW972IN

## Glazed Wall Cabinet

Height: 724mm  
Depth: 285mm  
Two adjustable glass shelves.  
See page 17 for glazed cabinet availability.  
Hand by hinge.  
Not available in Inline.  
18mm Excel cabinet only.  
110° Hinges



Width	Code
400mm	GDU472
500mm	GDU572

## Metallic Framed Glazed Wall Cabinet

Height: 724mm  
Depth: 285mm  
Two adjustable glass shelves.  
Hand by hinge.  
18mm Excel cabinet only.  
For soft close doors order SOFTCLOSEGL  
Not available in Inline.



Width	Code
400mm	GDU472SL
500mm	GDU572SL

## Corner Wall Cabinet

Height: 724mm  
Depth: 285mm  
Two adjustable shelves.  
Hand by blank, right hand blank shown.  
15mm cabinets are supplied with 170° hinges (for soft close doors order SOFTCL170) and 18mm cabinets with 110° hinges (for soft close doors order SMOVE1110).  
FP' suffix for a frontal matched flexible corner post.

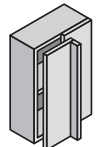

Width	Code
600mm 300 Door	CWU672
600mm 400 Door	CWU672FB
800mm 500 Door	CWU872FA
900mm 600 Door	CWU972FC

## Corner Wall Cabinet with Inset Handle

Height: 724mm  
Depth: 285mm  
Two adjustable shelves.  
Hand by blank, right hand blank shown.  
15mm cabinets are supplied with 170° hinges (for soft close doors order SOFTCL170) and 18mm cabinets with 110° hinges (for soft close doors order SMOVE1110).  
FP' suffix for a frontal matched flexible corner post.

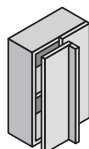

Width	Code
600mm 300 Door	CWU672IN
600mm 400 Door	CWU672INFB
800mm 500 Door	CWU872INFA
900mm 600 Door	CWU972INFC

## Microwave Wall Cabinet

Height: 724mm  
Depth: 330mm  
296 door  
47 fascia  
358 aperture  
This unit is deeper than standard wall units so will not line up. Check microwave dimensions before ordering. Typically 17 litre microwaves suit this housing. Maximum appliance dimensions 406mm high x 564mm wide.  
Not available in Inline.

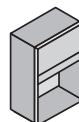

Width	Code
600mm	MWU672

# CABINETS 724MM HIGH FEATURE WALL CABINETS

## Accent Wall Open Display Units

Height: 724mm  
Depth: 285mm

Available in 18mm MFC matt colours: Blue, Cashmere, Dark Oak, Stone and Yellow.

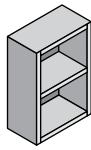

Width	Code
500mm	ODU572AC
600mm	ODU672AC

## Spice and Wine Rack Wall Cabinet

Height: 724mm  
Depth: 285mm

Four wine racks – holds up to 12 bottles.

Available in melamine cabinet colours.

18mm Excel cabinet only.  
Not available in Inline.



Width	Code
300mm Melamine	WWR372

## Spice and Wine Rack Cabinet

Height: 724mm  
Depth: 285mm

Five wine slots.

Available in melamine cabinet colours.

18mm Excel cabinet only.  
Not available in Inline.

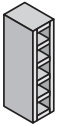

Width	Code
150mm Melamine	SPWR15

## Open Wall Cabinet

Height: 724mm  
Depth: 285mm

Single fixed shelf.

Available in melamine cabinet colours.

Not available in Inline.

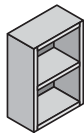

Width	Code
300mm Melamine	ODU372
400mm Melamine	ODU472
500mm Melamine	ODU572
600mm Melamine	ODU672

## Three Spice Drawer Wall Cabinet

Height: 724mm  
Depth: 285mm

Available in melamine cabinet colours.

18mm Excel cabinet only.  
Not available in Inline.

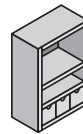

Width	Code
500mm Melamine	ODMW3572

## Plate Rack Wall Cabinet

Height: 724mm  
Depth: 285mm

Available in melamine cabinet colours.

18mm Excel cabinet only.  
Not available in Inline.

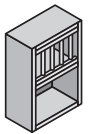

Width	Code
500mm Melamine	ODMW8572

## Lattice Wine Rack Wall Cabinet

Height: 724mm  
Depth: 285mm

Available in melamine cabinet colours.

18mm Excel cabinet only.  
Not available in Inline.

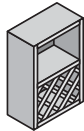

Width	Code
500mm Melamine	ODMW9572

## Plate and Lattice Wine Rack Wall Cabinet

Height: 724mm  
Depth: 285mm

Available in melamine cabinet colours.

18mm Excel cabinet only.  
Not available in Inline.



Width	Code
500mm Melamine	ODMW10572

## Open Display Wall Cabinet Frame

Height: 724mm

Available in Blonde Oak, Ivory and Painted Ivory.

Not available in Inline.

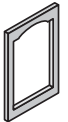

Width	Code
500mm	ODUFRAME

# CABINETS 900MM HIGH WALL CABINETS AND FEATURE CABINETS

## Single Wall Cabinet

Height: 900mm  
Depth: 285mm  
Two adjustable shelves.  
Hand by hinge.

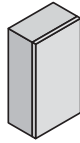

Width	Code
300mm	WU390
400mm	WU490
450mm	WU4590
500mm	WU590
600mm	WU690

## Single Wall Cabinet with Inset Handle

Height: 900mm  
Depth: 285mm  
Two adjustable shelves.  
Hand by hinge.  
Available in selected Inline and Contemporary ranges only. See page 17.

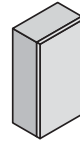

Width	Code
300mm	WU390IN
400mm	WU490IN
450mm	WU4590IN
500mm	WU590IN
600mm	WU690IN

## Double Wall Cabinet

Height: 900mm  
Depth: 285mm  
Two adjustable shelves.

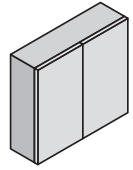

Width	Code
800mm	WU890
900mm	WU990
1000mm	WU1090

## Double Wall Cabinet with Inset Handle

Height: 900mm  
Depth: 285mm  
Two adjustable shelves.

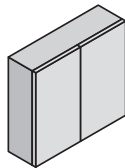

Width	Code
800mm	WU890IN
900mm	WU990IN
1000mm	WU1090IN

## Corner Wall Cabinet

Height: 900mm  
Depth: 285mm  
Two adjustable shelves.

Hand by blank, right hand blank shown.

15mm cabinets are supplied with 170° hinges (for soft close doors order SOFTCL170) and 18mm cabinets with 110° hinges (for soft close doors order SMOVE1110).  
FP' suffix for a frontal matched flexible corner post.

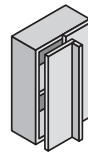

Width	Code
600mm 300 door	CWU690
600mm 400 door	CWU690FB
800mm 500 door	CWU890FA
900mm 600 door	CWU990FC

## Corner Wall Cabinet with Inset Handle

Height: 900mm  
Depth: 285mm  
Two adjustable shelves.  
Hand by blank, right hand blank shown.

15mm cabinets are supplied with 170° hinges (for soft close doors order SOFTCL170) and 18mm cabinets with 110° hinges (for soft close doors order SMOVE1110).

FP' suffix for a frontal matched flexible corner post.

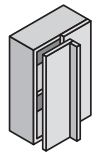

Width	Code
600mm 300 door	CWU690IN
600mm 400 door	CWU690INFB
800mm 500 door	CWU890INFA
900mm 600 door	CWU990INFC

## Glazed Wall Cabinet

Height: 900mm  
Depth: 285mm  
Two adjustable glass shelves.  
See page 17 for glazed cabinet availability.  
Hand by hinge.  
18mm Excel cabinet only.  
Not available in Inline.  
110° Hinges

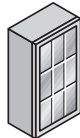

Width	Code
500mm	GDU590

## Spice and Wine Rack Wall Cabinet

Height: 900mm  
Depth: 285mm  
Five wine racks – holds up to 15 bottles.  
Available in melamine cabinet colours.  
18mm Excel cabinet only.  
Not available in Inline.



Width	Code
300mm Melamine	WWR390

## Open Wall Cabinet

Height: 900mm  
Depth: 285mm  
Single fixed shelf.  
Available in melamine cabinet colours.  
18mm Excel cabinet only.  
Not available in Inline.

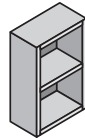

Width	Code
500mm Melamine	ODU590

## Three Spice Drawer Wall Cabinet

Height: 900mm  
Depth: 285mm  
Available in melamine cabinet colours  
18mm Excel cabinet only.  
Not available in Inline.

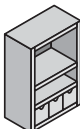

Width	Code
500mm Melamine	ODMW3590

## Open Display Wall Cabinet Frame

Height: 900mm  
Available in Blonde Oak, Ivory and Painted Ivory.  
Not available in Inline.



Width	Code
500mm	ODUFRAME90



# CABINETS BRIDGING CABINETS

## Over Cooker Hood

Height: 300mm  
Depth: 285mm  
Top lift door with flap stay.

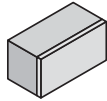

Width	Code
600mm	OCH63

## Over Cooker Hood with Inset Handle

Height: 300mm  
Depth: 285mm  
Top lift door with flap stay.  
Available in selected Inline and Contemporary ranges only.  
See page 17.

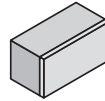

Width	Code
600mm	OCH63IN

## Glazed Over Cooker Hood

Height: 300mm  
Depth: 285mm  
Top lift door with gas piston lift.  
See page 17 for ranged glazed door availability.

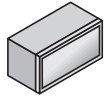

Width	Code
400	OCH43SL
500	OCH53SL
600	OCH63SL
800	OCH83SL
1000	OCH103SL

## Bridging Cabinet

Height: 362mm  
Depth: 285mm  
Cabinets line through with bi-fold cabinets.  
18mm Excel cabinet only.  
Top lift door with gas piston lift.

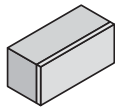

Width	Code
500mm	OCH536
600mm	OCH636
800mm	OCH836
900mm	OCH936

## Bridging Cabinet with Inset Handle

Height: 362mm  
Depth: 285mm  
Cabinets line through with bi-fold cabinets.  
Top lift door with gas piston lift.  
Available in selected Inline and Contemporary ranges only.  
See page 17.

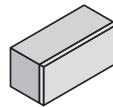

Width	Code
500mm	OCH536IN
600mm	OCH636IN
800mm	OCH836IN
900mm	OCH936IN

## Bridging Unit for 1000mm Wide American Fridge Freezers

Height: 280mm  
Depth: 285mm  
For use over American style side by side fridge freezer.  
Top lift door with flap stay.  
18mm Excel cabinet only.

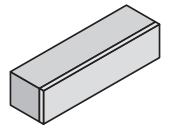

Width	Code
1000mm	OCH1028

## Bridging Unit for 1000mm Wide American Fridge Freezers with Inset Handle

Height: 280mm  
Depth: 285mm  
For use over American style side by side fridge freezer.  
Top lift door with flap stay.  
18mm Excel cabinet only.  
Available in selected Inline and Contemporary ranges only. See page 17.

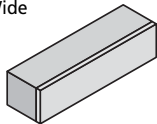

Width	Code
1000mm	OCH1028IN

## Accent Open Bridging Units

Height: 362mm  
Depth: 285mm  
Available in 18mm MFC matt colours: Blue, Cashmere, Dark Oak, Stone and Yellow.

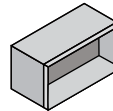

Width	Code
500mm	ODU536AC
600mm	ODU636AC
900mm	ODU936AC

# CABINETS BOILER HOUSINGS AND BASE OVEN HOUSINGS

## Wall Boiler Cabinet

Height: 724mm  
Depth: 400mm  
Boiler housings are not supplied with soft close doors in soft close kitchens.

Hand by hinge.  
Supplied RFA with 15mm Vista cabinet only.

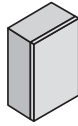

Width	Code
500mm	BH572
600mm	BH672

## Wall Boiler Cabinet with Inset Handle

Height: 724mm  
Depth: 400mm  
Boiler housings are not supplied with soft close doors in soft close kitchens.

Hand by hinge.  
Supplied RFA with 15mm Vista cabinet only.  
Available in Selected Inline and Contemporary ranges only. See page 17.

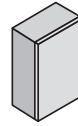

Width	Code
500mm	BH572IN
600mm	BH672IN

## Wall Boiler Cabinet

Height: 900mm  
Depth: 400mm  
Boiler housings are not supplied with soft close doors in soft close kitchens.

Hand by hinge.  
Supplied RFA.

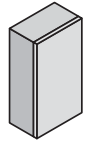

Width	Code
500mm	BH590
600mm	BH690

## Wall Boiler Cabinet with Inset Handle

Height: 900mm  
Depth: 400mm  
Boiler housings are not supplied with soft close doors in soft close kitchens.

Hand by hinge.  
Supplied RFA with 15mm Vista cabinet only.  
Available in Selected Inline and Contemporary ranges only. See page 17.

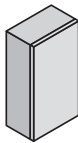

Width	Code
500mm	BH590IN
600mm	BH690IN

## Dresser Boiler Cabinet

Height: 1190mm  
Depth: 400mm  
900 door  
276 dummy drawer  
Boiler housings are not supplied with soft close doors in soft close kitchens.

Hand by hinge.  
18mm Excel cabinet only.  
Supplied RFA.

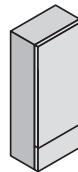

Width	Code
600mm	BH612

## Dresser Boiler Cabinet

Height: 1366mm  
Depth: 400mm  
1228 door  
120 fascia  
Boiler housings are not supplied with soft close doors in soft close kitchens.

Hand by hinge.  
18mm Excel cabinet only.  
Supplied RFA.

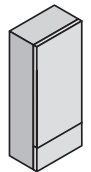

Width	Code
600mm	BH613

## Dresser Boiler Cabinet

Height: 1560mm  
Depth: 400mm  
1228 door  
47 fascia  
276 dummy drawer  
Boiler housings are not supplied with soft close doors in soft close kitchens.

Hand by hinge.  
Supplied RFA with 15mm Vista white cabinet only.

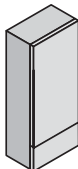

Width	Code
600mm	BH615

## Base Oven Housing

Height: 870mm  
Depth: 570mm  
72 fascia  
598 aperture  
47 fascia  
Check that hob and oven installation depths are compatible with the thickness of worktop.  
18mm Excel cabinet only.

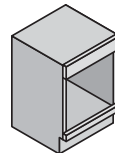

Width	Code
600mm	BOH66

## Built Under Microwave Housing

Height: 870mm  
Depth: 570mm  
72mm fascia  
459 aperture  
183 drawer  
Check that hob and oven installation depths are compatible with the thickness of worktop.  
18mm Excel cabinet only.

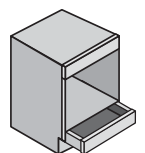

Width	Code
600mm	MBOH66

# CABINETS 2100MM HIGH LARDER CABINETS

## 70/30 Reduced Depth Larder Unit

Height: 2100mm  
 Depth: 285mm  
 1228 door  
 720 door  
 One fixed shelf and four additional shelves.  
 Hand by hinge.  
 18mm Excel cabinet only.



Width	Code
300mm with doors	LU33

## 70/30 Larder Cabinet

Height: 2100mm  
 Depth: 570mm  
 1228 door  
 720 door  
 One fixed shelf and four additional shelves.  
 Hand by hinge.



Width	Code
300mm	LU36
500mm	LU56
600mm	LU66

## 30/70 Larder Cabinet

Height: 2100mm  
 Depth: 570mm  
 720 door  
 1228 door  
 One fixed shelf and four additional shelves.  
 Hand by hinge.

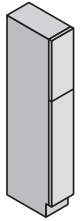

Width	Code
300mm	LU36B
500mm	LU56B
600mm	LU66B

## 50/50 Larder Cabinet

Height: 2100mm  
 Depth: 570mm  
 1018 door  
 930 door  
 One fixed shelf and four additional shelves.  
 Hand by hinge.



Width	Code
600mm	LU66A

## 70/30 Larder Cabinet with Internal Deep Drawers

Height: 2100mm  
 Depth: 570mm  
 1228 door  
 720 door  
 Five Revo internal deep drawers.  
 Drawers supplied separately.  
 Hand by hinge.



Width	Code
300mm	LU36ID
500mm	LU56ID
600mm	LU66ID

## 50/50 Larder Cabinet with Internal Drawers

Height: 2100mm  
 Depth: 570mm  
 1018 door  
 930 door  
 Five Revo internal deep drawers.  
 Drawers supplied separately.  
 Hand by hinge.

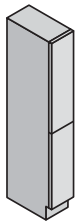

Width	Code
600mm	LU66AID

## 70/30 Larder Cabinet with Pull-out Chrome Baskets

Height: 2100mm  
 Depth: 570mm  
 Five pull out baskets to be fitted on-site  
 Not soft close.

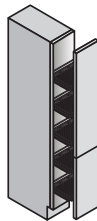

Width	Code
300mm	PL36

## 70/30 Corner Larder Cabinet

Height: 2100mm  
 Depth: 570mm  
 1228 door  
 720 door  
 Two doors, five additional shelves.  
 Supplied with blanking panel (750x2400mm).  
 Hand by blank.  
 18mm Excel cabinet only.  
 Supplied RFA.

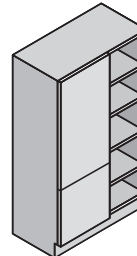

Width	Code
1000mm with 500mm doors	CNLU106
1000mm with 600mm doors	CNLU106C

## 50/50 Corner Larder Cabinet

Height: 2100mm  
 Depth: 570mm  
 1018 door  
 930 door  
 Two doors, five additional shelves.  
 Supplied with blanking panel (750x2400mm).  
 Hand by blank.  
 18mm Excel cabinet only.  
 Supplied RFA.

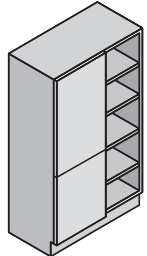

Width	Code
1000mm with 600mm doors	CNLU106A

# CABINETS 2100MM HIGH PANTRY UNITS

## Two Drawer Pantry Cabinet

Height: 2100mm  
 Depth: 570mm  
 1228 door (x1)  
 358 drawers (x2)  
 One top door and two deep pan drawers.  
 Three adjustable shelves.  
 Hand by hinge  
 18mm Excel cabinet only.



Width	Code
600mm	PU6621D2A

## Two Drawer Pantry Cabinet

Height: 2100mm  
 Depth: 570mm  
 1228 doors (x2)  
 358 drawers (x2)  
 Two top doors and two deep pan drawers.  
 Three adjustable shelves.  
 18mm Excel cabinet only.

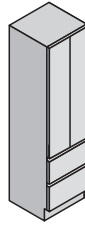

Width	Code
600mm	PU6621D2

## Three Drawer Pantry Cabinet

Height: 2100mm  
 Depth: 570mm  
 1228 doors (x1)  
 159 drawer  
 276 drawers (x2)  
 One top door, one shallow drawer and two pan drawers.  
 Three adjustable shelves.  
 Hand by hinge.  
 18mm Excel cabinet only.

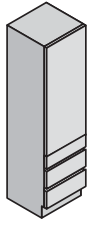

Width	Code
600mm	PU6621D3A

## Three Drawer Pantry Cabinet

Height: 2100mm  
 Depth: 570mm  
 1228 doors (x2)  
 159 drawer  
 276 drawers (x2)  
 Two top doors, one shallow drawer and two pan drawers.  
 Three adjustable shelves.  
 18mm Excel cabinet only.



Width	Code
600mm	PU6621D3

## Four Drawer Pantry Cabinet

Height: 2100mm  
 Depth: 570mm  
 1228 doors (x1)  
 159 drawer  
 183 drawers (x3)  
 One top door and four drawers.  
 Three adjustable shelves.  
 Hand by hinge.  
 18mm Excel cabinet only.

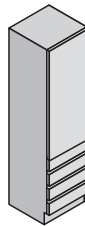

Width	Code
600mm	PU6621D4A

## Four Drawer Pantry Cabinet

Height: 2100mm  
 Depth: 570mm  
 1228 doors (x2)  
 159 drawer  
 183 drawers (x3)  
 Two top doors and four drawers.  
 Three adjustable shelves.  
 Not available in Inline.  
 18mm Excel cabinet only.

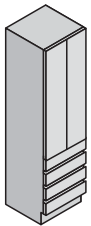

Width	Code
600mm	PU6621D4

## Pantry Cabinet

Height: 2100mm  
 Depth: 570mm  
 1228 doors (x2)  
 720 doors (x2)  
 Five adjustable shelves.  
 Supplied RFA.  
 18mm Excel cabinet only.

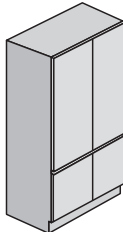

Width	Code
1000mm	PU106

# CABINETS 2276MM HIGH LARDER & PANTRY CABINETS

## 70/30 Reduced Depth Tall Larder Unit

Height: 2276mm  
Depth: 285mm  
1228 door  
896 door  
One fixed shelf and five additional shelves.  
Hand by hinge.



Width	Code
300mm	LU3323

## 70/30 Tall Larder Cabinet

Height: 2276mm  
Depth: 570mm  
1228 door  
896 door  
One fixed shelf and five additional shelves.  
Hand by hinge.



Width	Code
300mm	LU3623
500mm	LU5623
600mm	LU6623

## 50/50 Tall Larder Cabinet

Height: 2276mm  
Depth: 570mm  
1106 door  
1018 door  
One fixed shelf and four additional shelves.  
Hand by hinge.

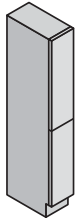

Width	Code
600mm	LU6623A

## 70/30 Tall Larder Cabinet with Internal Deep Drawers

Height: 2276mm  
Depth: 570mm  
1228 door  
896 door  
Five Revo internal deep drawers.  
Drawers supplied separately.  
Hand by hinge.



Width	Code
300mm	LU3623ID
500mm	LU5623ID
600mm	LU6623ID

## 50/50 Tall Larder Cabinet with Internal Drawers

Height: 2276mm  
Depth: 570mm  
1106 door  
1018 door  
Five Revo internal deep drawers.  
Drawers supplied separately.  
Hand by hinge.



Width	Code
600mm	LU6623AID

## Tall 70/30 Larder Cabinet with Standard Pull-out Chrome Baskets

Height: 2276mm  
Depth: 570mm  
Single fixed shelf.  
Five pull out baskets to be fitted on-site.  
Not soft close.

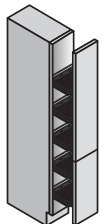

Width	Code
300mm	PL3623

## Tall 70/30 Corner Larder Cabinet

Height: 2276mm  
Depth: 570mm  
1228 door  
896 door  
Two doors, five additional shelves.  
Supplied with blanking panel (750x2400mm).  
Hand by blank.  
18mm Excel cabinet only.  
Supplied RFA.

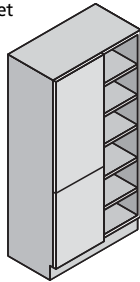

Width	Code
1000mm with 500mm doors	CNLU10623
1000mm with 600mm doors	CNLU10623C

## Tall 50/50 Corner Larder Cabinet

Height: 2276mm  
Depth: 570mm  
1106x600 door  
1018x600 door  
Two doors, five additional shelves.  
Supplied with blanking panel (750x2400mm).  
Hand by blank.  
18mm Excel cabinet only.  
Supplied RFA.

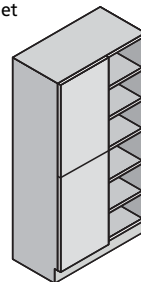

Width	Code
1000mm with 600mm doors	CNLU10623A

## Tall Pantry Cabinet

Height: 2276mm  
Depth: 570mm  
1228 doors (x2)  
896 door (x2)  
Five adjustable shelves.  
18mm Excel cabinet only.  
Supplied RFA.

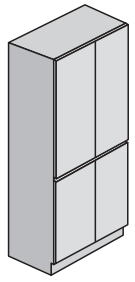

Width	Code
1000mm	PU10623

# CABINETS 2100MM HIGH OVEN HOUSINGS

## Single Oven Housing

Height: 2100mm  
Depth: 570mm  
557 door  
72 fascia  
595 aperture  
159 drawer  
557 door  
Hand by hinge.

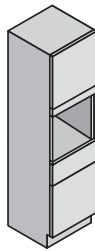

Width	Code
600mm	OH664A

## Single Oven Housing

Height: 2100mm  
Depth: 570mm  
720 door  
72 fascia  
595 aperture  
557 door  
Hand by hinge.

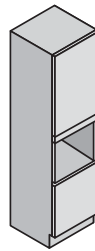

Width	Code
600mm	OH665A

## Single Oven Housing

Height: 2100mm  
Depth: 570mm  
557 door  
72 fascia  
595 aperture  
720 door  
Hand by hinge.

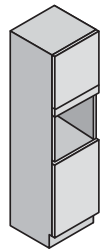

Width	Code
600mm	OH666A

## Single Oven Housing

Height: 2100mm  
Depth: 570mm  
557 door  
72 fascia  
594 aperture  
159 drawer  
276 drawer  
276 drawer  
Hand by hinge.

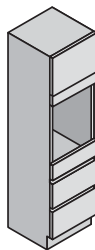

Width	Code
600mm	OH6610A

## Single Oven Housing

Height: 2100mm  
Depth: 570mm  
557 door  
72 fascia  
594 aperture  
358 drawer  
358 drawer  
Hand by hinge.

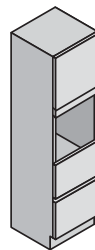

Width	Code
600mm	OH6610E

## Single Oven and Microwave/Compact Oven Housing

Height: 2100mm  
Depth: 570mm  
450 door  
72 fascia  
459 aperture  
18 shelf  
595 aperture  
358 drawer  
Hand by hinge.

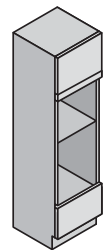

Width	Code
600mm	OH661F

## Single Oven and Microwave/Compact Oven Housing

Height: 2100mm  
Depth: 570mm  
450 door  
47 fascia  
388 aperture  
18 shelf  
595 aperture  
450 drawer  
Hand by hinge.  
Drawer contains one wirework basket and one metal sided basket.

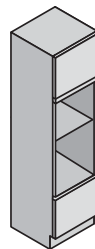

Width	Code
600mm	OH662A

## Single Oven and Microwave/Compact Oven Housing

Height: 2100mm  
Depth: 570mm  
358 flap  
72 fascia  
459 aperture  
18 shelf  
590 aperture  
450 drawer  
Hand by hinge.  
Drawer contains one wirework basket and one metal sided basket.

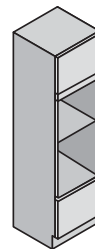

Width	Code
600mm	OH662N

## Single Oven Housing

Height: 2100mm  
Depth: 570mm  
896 door  
590 aperture  
450 drawer  
Hand by hinge.  
Drawer contains one wirework basket and one metal sided basket.

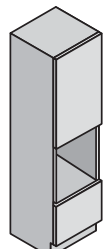

Width	Code
600mm	OH662O

## Single Oven and Integrated Fridge Housing

Height: 2100mm  
Depth: 570mm  
358 flap  
72 fascia  
595 aperture  
930 door  
Hand by hinge.  
Check fridge freezer specification. Frontals are hinged to cabinets designed for slider fixing appliances. Appliance frontals are supplied separately to the cabinet for door-on-door appliances.

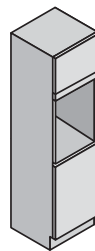

Width	Code
600mm (slider fixing appliances)	OFH66A
600mm (door-on-door appliances)	OFH66AND
Cabinet without appliance doors	DRIFBOT1ASS
930 appliance door	

## Microwave/Compact Oven Housing

Height: 2100mm  
Depth: 570mm  
720 door  
47 fascia  
457 aperture  
720 door

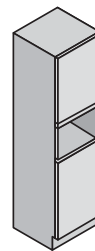

Width	Code
600mm	OH667A

## Microwave/Compact Appliance Housing

Height: 2100mm  
Depth: 570mm  
720 door  
120 fascia  
384 aperture  
720 door

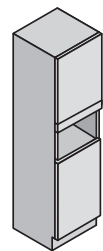

Width	Code
600mm	OH667B

# CABINETS 2100MM HIGH OVEN HOUSINGS

## Microwave/Compact Oven Housing

Height: 2100mm  
Depth: 570mm  
296 flap  
72 fascia  
18 shelf  
377 aperture  
462 aperture  
720 door

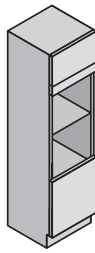

Width	Code
600mm	OH669A

## Compact Appliance Housing

Height: 2100mm  
Depth: 570mm  
296 flap  
72 fascia  
18 shelf  
72 fascia  
377 aperture  
406 aperture  
720 door  
Hand by hinge.

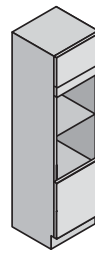

Width	Code
600mm	OH669B

## Microwave/Compact Oven Housing

Height: 2100mm  
Depth: 570mm  
720 door  
47 fascia  
456 aperture  
159 drawer  
276 drawer  
276 drawer  
Hand by hinge.

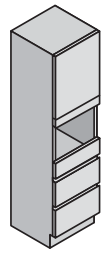

Width	Code
600mm	OH6610D

## Microwave/Compact Oven Housing

Height: 2100mm  
Depth: 570mm  
720 door  
47 fascia  
456 aperture  
358 drawer  
358 drawer  
Hand by hinge.

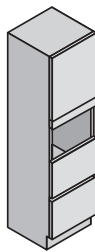

Width	Code
600mm	OH6610G

## Microwave/Compact Oven Housing

Height: 2100mm  
Depth: 570mm  
296 flap  
72 fascia  
390 aperture  
72 fascia  
393 aperture  
159 drawer  
276 drawer  
276 drawer

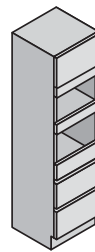

Width	Code
600mm	OH6610C

## Compact Oven and Integrated Fridge Housing

Height: 2100mm  
Depth: 570mm  
557 door  
457 aperture  
930 door  
Hand by hinge.  
Check fridge freezer specification. Frontals are hinged to cabinets designed for slider fixing appliances. Appliance frontals are supplied separately to the cabinet for door-on-door appliances.

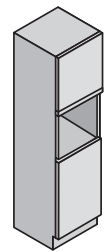

Width	Code
600mm (slider fixing appliances)	OFH66B
600mm (door-on-door appliances)	OFH66BND
Cabinet without appliance doors	DRIFBOT1ASS
930 appliance door	

## Microwave/Compact Oven Housing

Height: 2100mm  
Depth: 570mm  
296 flap  
72 fascia  
390 aperture  
72 fascia  
393 aperture  
358 drawer  
358 drawer

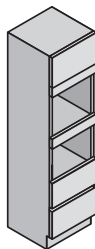

Width	Code
600mm	OH6610F

## Double Oven Housing

Height: 2100mm  
Depth: 570mm  
450 door  
47 fascia  
890 aperture  
557 door  
Hand by hinge.

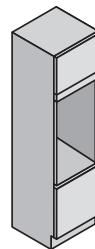

Width	Code
600mm	OH663A

## Double Oven Housing

Height: 2100mm  
Depth: 570mm  
450 door  
47 fascia  
889 aperture  
276 drawer  
276 drawer  
Hand by hinge.

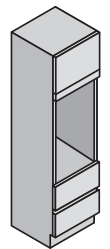

Width	Code
600mm	OH6610B

## Double Oven and Compact Appliance Housing

Height: 2100mm  
Depth: 570mm  
296 flap  
457 aperture  
18 shelf  
875 aperture  
296 drawer

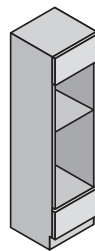

Width	Code
600mm	OH668C

## Double Oven and Compact Appliance Housing

Height: 2100mm  
Depth: 570mm  
450 door  
72 fascia  
455 aperture  
18 shelf  
888 aperture  
72 fascia

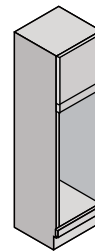

Width	Code
600mm	OH668D

**Important:** Please check the appliance manufacturer's instructions as to the venting requirements for any particular appliance. All appliances must be fitted strictly in accordance with the manufacturer's instructions. Check appliance dimensions fit the appliance housing before ordering. Fascia panels can be cut to suit. Edging tape is available for re-edging the fascia after cutting.

# CABINETS 2276MM HIGH OVEN HOUSINGS

## Single Oven Housing

Height: 2276mm  
Depth: 570mm  
720 door  
72 fascia  
608 aperture  
159 drawer  
557 door  
Hand by hinge.

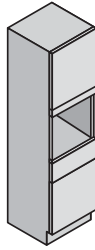

Width	Code
600mm	OH66234A

## Single Oven Housing

Height: 2276mm  
Depth: 570mm  
896 door  
72 fascia  
595 aperture  
557 door  
Hand by hinge.

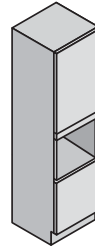

Width	Code
600mm	OH66235A

## Single Oven Housing

Height: 2276mm  
Depth: 570mm  
557 door  
72 fascia  
595 aperture  
896 door  
Hand by hinge.

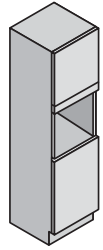

Width	Code
600mm	OH66236A

## Single Oven Housing

Height: 2276mm  
Depth: 570mm  
720 door  
72 fascia  
607 aperture  
159 drawer  
276 drawer  
276 drawer  
Hand by hinge.

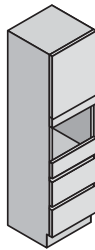

Width	Code
600mm	OH662310A

## Single Oven Housing

Height: 2276mm  
Depth: 570mm  
720 door  
72 fascia  
607 aperture  
358 drawer  
358 drawer  
Hand by hinge.

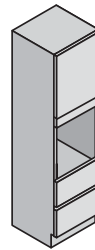

Width	Code
600mm	OH662310E

## Single Oven and Microwave/ Compact Oven Housing

Height: 2276mm  
Depth: 570mm  
720 door  
47 fascia  
459 aperture  
18 shelf  
595 aperture  
296 drawer  
Hand by hinge.

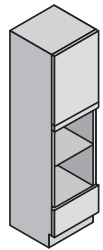

Width	Code
600mm	OH66231A

## Single Oven and Microwave/ Compact Oven Housing

Height: 2276mm  
Depth: 570mm  
557 door  
120 fascia  
479 aperture  
18 shelf  
595 aperture  
72 fascia  
296 drawer



Width	Code
600mm	OH66231C

## Single Oven and Microwave/ Compact Oven Housing

Height: 2276mm  
Depth: 570mm  
557 door  
120 fascia  
375 aperture  
18 shelf  
595 aperture  
450 drawer  
Hand by hinge.  
Drawer contains one wirework basket and one metal sided basket.

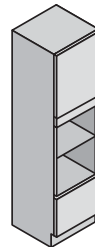

Width	Code
600mm	OH66232A

## Single Oven and Microwave/compact appliance Housing

Height: 2276mm  
Depth: 570mm  
557 door  
120 fascia  
390 aperture  
18 shelf  
590 aperture  
450 drawer  
Drawer contains one wirework basket and one metal sided basket.

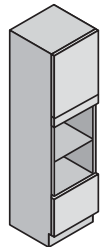

Width	Code
600mm	OH66232H

## Single Oven and Microwave/compact appliance Housing

Height: 2276mm  
Depth: 570mm  
557 door  
47 fascia  
459 aperture  
18 shelf  
595 aperture  
450 drawer  
Drawer contains one wirework basket and one metal sided basket.

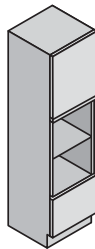

Width	Code
600mm	OH66232I

## Single Oven and Integrated Fridge Housing

Height: 2276mm  
Depth: 570mm  
557 door  
47 fascia  
594 aperture  
930 door  
Hand by hinge.  
Check fridge freezer specification. Frontals are hinged to cabinets designed for slider fixing appliances. Appliance frontals are supplied separately to the cabinet for door-on-door appliances.

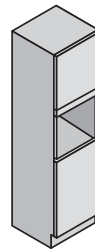

Width	Code
600mm (slider fixing appliances)	OHF6623C
600mm (door-on-door appliances)	OHF6623CND
Cabinet without appliance doors	DRIFBOT1ASS
930 appliance door	

## Microwave/Compact Oven Housing

Height: 2276mm  
Depth: 570mm  
896 door  
47 fascia  
457 aperture  
720 door  
Hand by hinge.

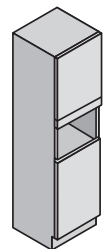

Width	Code
600mm	OH66237A



# CABINETS 2276MM HIGH INTEGRATED HOUSINGS

## Microwave/Compact Appliance Housing

Height: 2276mm  
Depth: 570mm

896 door  
120 fascia  
382 aperture  
720 door

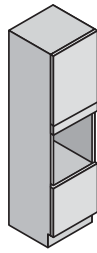

Width	Code
600mm	OH66237B

## Microwave/Compact Oven Housing

Height: 2276mm  
Depth: 570mm

896 door  
47 fascia  
456 aperture  
159 drawer  
276 drawer  
276 drawer  
Hand by hinge.

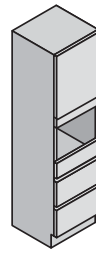

Width	Code
600mm	OH662310D

## Microwave/Compact Oven Housing

Height: 2276mm  
Depth: 570mm

896 door  
47 fascia  
456 aperture  
358 drawer  
358 drawer  
Hand by hinge.

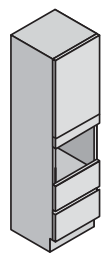

Width	Code
600mm	OH662310G

## Microwave/Compact Oven Housing

Height: 2276mm  
Depth: 570mm

557 door  
72 fascia  
770 aperture  
159 drawer  
276 drawer  
276 drawer  
Hand by hinge.

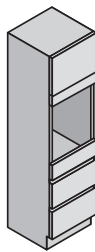

Width	Code
600mm	OH662310C

## Microwave/Compact Oven Housing

Height: 2276mm  
Depth: 570mm

557 door  
72 fascia  
770 aperture  
358 drawer  
358 drawer  
Hand by hinge.

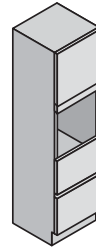

Width	Code
600mm	OH662310F

## Compact Oven and Integrated Fridge Housing

Height: 2276mm  
Depth: 570mm

720 door  
47 fascia  
455 aperture  
930 door  
Hand by hinge.  
Check fridge freezer specification.  
Frontals are hinged to cabinets designed for slider fixing appliances.  
Appliance frontals are supplied door-on-door appliances.

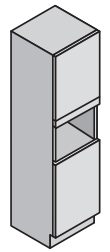

Width	Code
600mm	OFH6623D
600mm (door-on-door appliances)	OFH6623DND
Cabinet without appliance doors	DRIFBOT1ASS
930 appliance door	

## Double Oven Housing

Height: 2276mm  
Depth: 570mm

557 door  
120 fascia  
890 aperture  
557 door  
Hand by hinge.

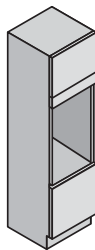

Width	Code
600mm	OH66233A

## Double Oven Housing

Height: 2276mm  
Depth: 570mm

557 door  
120 fascia  
885 aperture  
276 drawer  
276 drawer  
Hand by hinge.

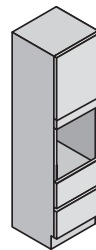

Width	Code
600mm	OH662310B

## Double Oven and Microwave/Compact Appliance Housing

Height: 2276mm  
Depth: 570mm

450 door  
47 fascia  
453 aperture  
18 shelf  
888 aperture  
276 drawer

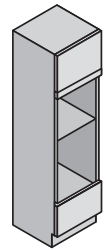

Width	Code
600mm	OH66238A

## Double Oven and Microwave/Compact Appliance Housing

Height: 2276mm  
Depth: 570mm

450 door  
120 fascia  
380 aperture  
18 shelf  
888 aperture  
276 drawer

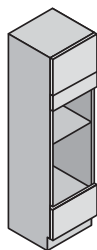

Width	Code
600mm	OH66238B

## Oven Housing Fascia Panels

600w replacement fascia panels

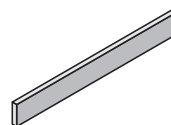

Height	Code
47mm	FAAH4
72mm	FAAH7
120mm	FAAHB

**Important:** Please check the appliance manufacturer's instructions as to the venting requirements for any particular appliance. All appliances must be fitted strictly in accordance with the manufacturer's instructions. Check appliance dimensions fit the appliance housing before ordering. Fascia panels can be cut to suit. Edging tape is available for re-edging the fascia after cutting.

# CABINETS 2100MM & 2276MM HIGH INTEGRATED FRIDGE/ FREEZER HOUSINGS

## 50/50 Integrated Housing

Height: 2100mm  
Depth: 570mm

1018 door  
930 door

Hand by hinge.

One appliance behind top and bottom door.

Check fridge freezer specification. Frontals are hinged to cabinets designed for slider fixing appliances. Appliance frontals are supplied separately to the cabinet for door-on-door appliances.

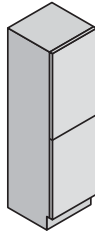

Width	Code
600mm (slider fixing appliances)	<b>IF66A</b>
600mm (door-on-door appliances)	
Cabinet without appliance doors	<b>IF66AND</b>
1018 appliance door	<b>DRIFTOP1ASS</b>
930 appliance door	<b>DRIFBOT1ASS</b>

## In-Column Integrated Housing

Height: 2100mm  
Depth: 570mm

720 door  
1228 door

Hand by hinge.

One appliance behind bottom door.

Check fridge freezer specification. Frontals are hinged to cabinets designed for slider fixing appliances. Appliance frontals are supplied separately to the cabinet for door-on-door appliances.

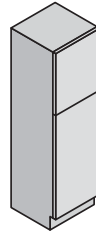

Width	Code
600mm (slider fixing appliances)	<b>IF66B</b>
600mm (door-on-door appliances)	
Cabinet without appliance doors	<b>IF66BND</b>
1228 appliance door	<b>DRIFBOT2ASS</b>

## In-Column Integrated Housing

Height: 2100mm  
Depth: 570mm

296 flap  
930 door  
720 door

Hand by hinge.

One appliance behind middle door.

Check fridge freezer specification. Frontals are hinged to cabinets designed for slider fixing appliances. Appliance frontals are supplied separately to the cabinet for door-on-door appliances.

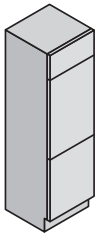

Width	Code
600mm (slider fixing appliances)	<b>IF66C</b>
600mm (door-on-door appliances)	
Cabinet without appliance doors	<b>IF66CND</b>
930 appliance door	<b>DRIFMIDASS</b>

## 70/30 Integrated Housing

Height: 2100mm  
Depth: 570mm

1228 door  
720 door

Hand by hinge.

One appliance behind top and bottom door.

Check fridge freezer specification. Frontals are hinged to cabinets designed for slider fixing appliances. Appliance frontals are supplied separately to the cabinet for door-on-door appliances.

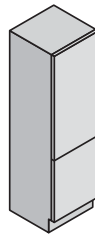

Width	Code
600mm (slider fixing appliances)	<b>IF66D</b>
600mm (door-on-door appliances)	
Cabinet without appliance doors	<b>IF66DND</b>
1228 appliance door	<b>DRIFTOP2ASS</b>
720 appliance door	<b>DRIFBOT3ASS</b>

## 70/30 Integrated Housing

Height: 2100mm Depth: 570mm  
1228 door 720 door

Hand by hinge.

For use with NEFF, Bosch and Siemens appliances only (appliance sits higher to allow it to align with doors).

One appliance behind top and bottom door.

Check fridge freezer specification. Frontals are hinged to cabinets designed for slider fixing appliances. Appliance frontals are supplied separately to the cabinet for door-on-door appliances.

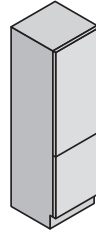

Width	Code
600mm (slider fixing appliances)	<b>IF66G</b>
600mm (door-on-door appliances)	
Cabinet without appliance doors	<b>IF66GND</b>
1228 appliance door	<b>DRIFTOP2GASS</b>
720 appliance door	<b>DRFH6GASS</b>

## Tall In-Column Integrated Housing

Height: 2276mm  
Depth: 570mm

896 door  
1228 door

Hand by hinge.

One appliance behind bottom door.

Check fridge freezer specification. Frontals are hinged to cabinets designed for slider fixing appliances. Appliance frontals are supplied separately to the cabinet for door-on-door appliances.

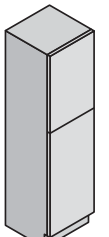

Width	Code
600mm (slider fixing appliances)	<b>IF6623B</b>
600mm (door-on-door appliances)	
Cabinet without appliance doors	<b>IF6623BND</b>
1228 appliance door	<b>DRIFBOT2ASS</b>

## Tall In-Column Integrated Housing

Height: 2276mm  
Depth: 570mm

296 flap  
930 door  
896 door

Hand by hinge.

One appliance behind middle door.

Check fridge freezer specification. Frontals are hinged to cabinets designed for slider fixing appliances. Appliance frontals are supplied separately to the cabinet for door-on-door appliances.

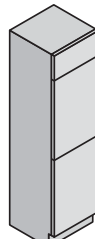

Width	Code
600mm (slider fixing appliances)	<b>IF6623C</b>
600mm (door-on-door appliances)	
Cabinet without appliance doors	<b>IF6623CND</b>
930 appliance door	<b>DRIFMIDASS</b>

## Tall 70/30 Integrated Housing

Height: 2276mm  
Depth: 570mm

1228 door  
896 door

Hand by hinge.

One appliance behind top and bottom door.

Check fridge freezer specification. Frontals are hinged to cabinets designed for slider fixing appliances. Appliance frontals are supplied separately to the cabinet for door-on-door appliances.

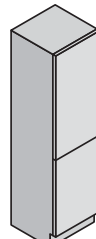

Width	Code
600mm (slider fixing appliances)	<b>IF6623D</b>
600mm (door-on-door appliances)	
Cabinet without appliance doors	<b>IF6623DND</b>
1228 appliance door	<b>DRIFTOP2ASS</b>
896 appliance door	<b>DRAHBOT1ASS</b>

## Tall 70/30 Integrated Housing

Height: 2276mm Depth: 570mm  
1228 door 896 door

Hand by hinge.

For use with NEFF, Bosch and Siemens appliances only (appliance sits higher to allow it to align with doors).

One appliance behind top and bottom door.

Check fridge freezer specification. Frontals are hinged to cabinets designed for slider fixing appliances. Appliance frontals are supplied separately to the cabinet for door-on-door appliances.

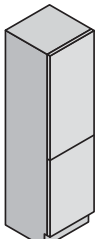

Width	Code
600mm (slider fixing appliances)	<b>IF6623G</b>
600mm (door-on-door appliances)	
Cabinet without appliance doors	<b>IF6623GND</b>
1228 appliance door	<b>DRIFTOP2GASS</b>
896 appliance door	<b>DRAHBOT1GASS</b>

## Tall 50/50 Integrated Housing

Height: 2276mm  
Depth: 570mm

1106 door  
1018 door

Hand by hinge.

One appliance behind top and bottom door.

Check fridge freezer specification. Frontals are hinged to cabinets designed for slider fixing appliances. Appliance frontals are supplied separately to the cabinet for door-on-door appliances.

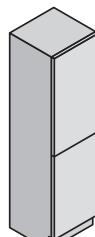

Width	Code
600mm (slider fixing appliances)	<b>IF6623J</b>
600mm (door-on-door appliances)	
Cabinet without appliance doors	<b>IF6623JND</b>
1106 appliance door	<b>DRIFTOP6ASS</b>
1018 appliance door	<b>DRIFBOT4ASS</b>

## Tall 70/30 Integrated Housing

Height: 2276mm Depth: 570mm

296 flap  
1106 door  
720 door

Hand by hinge.

One appliance behind top and bottom door.

Check fridge freezer specification. Frontals are hinged to cabinets designed for slider fixing appliances. Appliance frontals are supplied separately to the cabinet for door-on-door appliances.

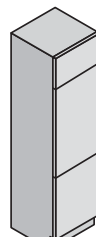

Width	Code
600mm (slider fixing appliances)	<b>IF6623K</b>
600mm (door-on-door appliances)	
Cabinet without appliance doors	<b>IF6623KND</b>
1106 appliance door	<b>DRIFTOP6ASS</b>
720 appliance door	<b>DRFH6ASS</b>

# CABINETS INTEGRATED APPLIANCE DOORS & COOKER HOOD DOORS

**450w Slimline Dishwasher Door (drilled)**  
IDFD45ASS to be joined on site.



Height	Code
720mm Door	<b>DRDW45ASS</b>
557mm Door	<b>IDFD45ASS</b>
159mm Drawer and Joining Plates	

**500w Slimline Dishwasher Door (drilled)**  
DRDW5ASS to be joined on site.



Height	Code
720mm Door	<b>DRFH5ASS</b>
557mm Door	<b>DRDW5ASS</b>
159mm Drawer and Joining Plates	

**600w Integrated Appliance Door (undrilled)**  
IDFD2ASS to be joined on site.

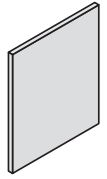

Height	Code
720mm Door for Integrated Appliance	<b>DRFH6UDASS</b>
557mm Door for Semi-Integrated Appliances	<b>DRDL6UDASS</b>
557mm Door 159mm Door, Drawer and Joining Plates	<b>IDFD2ASS</b>

## Integrated Cooker Hood Door

Height: 450mm  
Inset handles available in selected ranges. See page 17.  
British Standard BS6172 recommended hob clearance heights are 650mm for electric and 750mm for gas hobs in the absence of manufacturers instructions. Check specific appliance instructions for actual dimensions required.

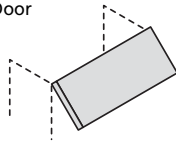

Width	Code
600mm	<b>DRICASS</b>
600mm with Inset Handle	<b>DRICIN</b>

## Integrated Cooker Hood Door

Height: 560mm  
Inset handles available in selected ranges. See page 17.  
British Standard BS6172 recommended hob clearance heights are 650mm for electric and 750mm for gas hobs in the absence of manufacturers instructions. Check specific appliance instructions for actual dimensions required.

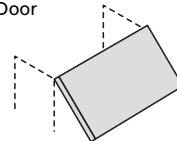

Width	Code
600mm	<b>DRIC56ASS</b>
600mm with Inset Handle	<b>DRIC56IN</b>

# CABINETS MID HEIGHT CABINETS

## Four Drawer Pack

Height: 1381mm  
Depth: 570mm  
120 fascia  
276 drawer (x4)  
18mm Excel Cabinets only.  
Not available in Inline.

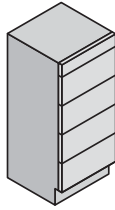

Width	Code
600mm	PD66D4

## Single Oven Housing

Height: 1381mm  
Depth: 570mm  
595 aperture  
557 door  
Hand by hinge.  
18mm Excel Cabinets only.  
Not available in Inline.

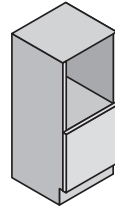

Width	Code
600mm	SOH6613

## Single Oven/Microwave Housing

Height: 1381mm  
Depth: 570mm  
72 fascia  
422 aperture  
72 fascia  
595 aperture  
120 fascia  
18mm Excel Cabinets only.  
Not available in Inline.

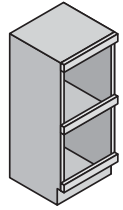

Width	Code
600mm	SOH6613A

## Double Oven Housing

Height: 1381mm  
Depth: 570mm  
47 fascia  
885 aperture  
296 drawer  
18mm Excel Cabinets only.  
Not available in Inline.

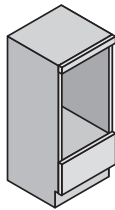

Width	Code
600mm	DOH6613

## Fridge Housing

Height: 1381mm  
Depth: 570mm  
930 door  
296 drawer  
Hand by hinge.  
18mm Excel Cabinets only.  
Not available in Inline.  
Check fridge freezer specification.  
Frontals are hinged to cabinets designed for slider fixing appliances. Appliance frontals are supplied separately to the cabinet for door-on-door appliances.

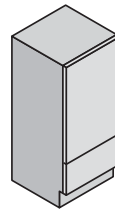

Width	Code
600mm (slider fixing appliances)	IF6613
600mm (door-on-door appliances)	IF6613ND
Cabinet without appliance doors	DRIFBOT1ASS
930 appliance door	

## Microwave Oven Housing

Height: 1381mm  
Depth: 570mm  
47 fascia  
450 aperture  
159 drawer  
276 drawer (x2)  
18mm Excel Cabinets only.  
Not available in Inline.

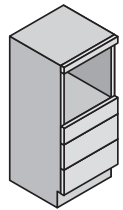

Width	Code
600mm	MOH6613D3

## Larder Cabinet

Height: 1381mm  
Depth: 570mm  
1228 door  
Three shelves.  
Hand by hinge.  
18mm Excel Cabinets only.  
Not available in Inline.

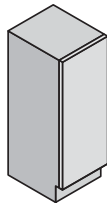

Width	Code
500mm	LU5613
600mm	LU6613

# CABINETS TALL WORKTOP DRESSER CABINETS

## Glazed Dresser Cabinet with Three Spice Drawers

Height: 1190mm  
Depth: 285mm

Three glass shelves.

See page 17 for ranged glazed door availability.

WDU512SL to be ordered for all other ranges.

18mm Excel Cabinets only.

Not available in Inline.

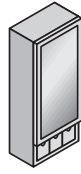

Width	Code
500mm (ranged)	WDU512
500mm (stainless steel)	WDU512SL

## Glazed Dresser Cabinet with Single Spice Drawer

Height: 1190mm  
Depth: 285mm

Three glass shelves.

See page 17 for ranged glazed door availability.

WDU512BSL to be ordered for all other ranges.

18mm Excel Cabinets only.

Not available in Inline.



Width	Code
500mm (ranged)	WDU512B
500mm (stainless steel)	WDU512BSL

## Tall Glazed Dresser Cabinet with Three Spice Drawers

Height: 1366mm  
Depth: 285mm

Three glass shelves.

See page 17 for ranged glazed door availability.

WDU513ASL to be ordered for all other ranges.

18mm Excel Cabinets only.

Not available in Inline.

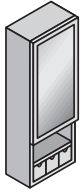

Width	Code
500mm (ranged)	WDU513A
500mm (stainless steel)	WDU513ASL

## Tall Glazed Dresser Cabinet with Single Spice Drawer

Height: 1366mm  
Depth: 285mm

Three glass shelves.

See page 17 for ranged glazed door availability.

WDU513BSL to be ordered for all other ranges.

18mm Excel Cabinets only.

Not available in Inline.



Width	Code
500mm (ranged)	WDU513B
500mm (stainless steel)	WDU513BSL

# RECOMMENDED BLENDER PANELS, FILLER PANELS & PLINTHS

Three specifications of panels are available. Choose a C, R or F on the end of the code to ensure the panels co-ordinate with either the cabinet, replacement end or frontal throughout the kitchen.

SPEC LEVEL	FILLER PANEL	WALL BLENDER	BASE BLENDER	TALL BLENDER	SHELVING	BREAKFAST BAR PANEL	BREAKFAST BAR PANEL	PLINTH (INC SEAL)
DIMENSIONS	970x352x18mm	970x352x18mm	920x650x18mm	2400x750x18mm	2600x352x18mm	920x900x18mm*	920x1800x18mm	2600x142mm (minimum size)
STANDARD	BWU390C	BWU390C	BBU6592C	BLU7523C	SHPANEL24C		BBBP1892C	CONPLINTHC
REPLACEMENT ENDS	BWU390R	BWU390R	BBU6592R	BLU7523R	SHPANEL24R	BBBP992R	BBBP1892R	CONPLINTHR
FRONTAL CO-ORDINATED	BWU390F	BWU390F	BBU6592F	BLU7523F	SHPANEL24F	BBBP992F	BBBP1892F	CONPLINTHF

Cabinet colour panels are matt MFC material. Panels that match replacement ends will be a combination of cabinet and frontal co-ordinating panels.

**Note:**

Alta and Inline Select Gloss Mussel and Gloss Pure White have 350mm deep filler, wall and shelving panels.

All Boston and Salerno panels are 22mm (except Breakfast Bar panels) and the shelving panels are 2400mm.

\* 900mm Breakfast bars are available in selected ranges. An 1800mm panel and edging tape will be supplied for any range that has a Cabinet Matched panel specification on p49 and for Austin, Colorado, Hacienda, Kansas, Minnesota, Newport, Oakham, Plaza Mussel and Plaza Stone.

# RANGE PANEL SPECIFICATION

Standard 'C' panels and CPOSTPNL72/90 corner post panels are matt MFC material and will match the selected cabinet colour.

Frontal co-ordinated 'F' panels and replacement end 'R' panels are a combination of frontal material and cabinet material as detailed below.

RANGE	COLOUR	FINISH
ALTA MUSSEL	Mussel	Gloss Painted
ALTA PURE WHITE	White	Gloss Painted
AUSTIN*	Painted Ivory (F)	Painted (Planked/Plain) Shelving panels (Plain/ Plain)
	Cabinet Matched (R)	Matt MFC
BOSTON IVORY	Ivory	Gloss PVC Wrapped
BOSTON WHITE	White	Gloss PVC Wrapped
CALGARY WHITE	Cabinet Matched	Matt MFC
COLORADO	Dark Oak	Textured Matt MFC
CRANBROOK IVORY*	Ivory (F)	PVC Wrapped
	Cabinet Matched (R)	Matt MFC
CRANBROOK PLATINUM	Platinum	PVC Wrapped
CRANBROOK SAGE	Sage	PVC Wrapped
CRANBROOK STONE	Stone	PVC Wrapped
GEORGIA OAK	Cabinet Matched	Matt MFC
GEORGIA WALNUT	Cabinet Matched	Matt MFC
HACIENDA CHAMPAGNE	Avola Champagne	Matt MFC
HACIENDA IVORY	Avola Ivory	Matt MFC
HACIENDA WHITE ASH	Avola White Ash	Matt MFC
KANSAS	Light Ash	Textured Matt MFC
MEDFORD	Cabinet Matched	Matt MFC
MINNESOTA	Avola Grey	Textured Matt MFC
NEWPORT*	Ivory (F)	Matt PVC (Plinth MFC)
	Cabinet Matched (R)	Matt MFC
NEW YORK CASHMERE	Cashmere	Gloss Painted
NEW YORK IVORY	Ivory	Gloss Painted

RANGE	COLOUR	FINISH
NEW YORK WHITE	White	Gloss Painted
OAKHAM*	Blonde Oak (F)	Veneered (Planked/Plain) Shelving panels (Plain/ Plain)
	Cabinet Matched (R)	Matt MFC
OREGON GREY	Cabinet Matched	Matt MFC
OREGON CREAM	Cabinet Matched	Matt MFC
OREGON WHITE	Cabinet Matched	Matt MFC
ORLANDO DAKAR	Dakar	Gloss Acrylic
ORLANDO GREY	Grey	Gloss Acrylic
ORLANDO WHITE	White	Gloss Painted
PLAZA CASHMERE	Cashmere	Matt MFC Grained
PLAZA MUSSEL	Mussel	Matt MFC Grained
PLAZA PORCELAIN	Porcelain	Matt MFC Grained
PLAZA STONE	Stone	Matt MFC Grained
SALERNO IVORY	Ivory	Gloss PVC Wrapped
SALERNO WHITE	White	Gloss PVC Wrapped
VIRGINIA OAK	Cabinet Matched	Matt MFC
VIRGINIA WALNUT	Cabinet Matched	Matt MFC
WESTPORT IVORY	Ivory	Matt Lacquered MFC
WESTPORT WHITE	White	Matt Lacquered MFC
WOODBURY ANTHRACITE	Anthracite	Gloss Painted
WOODBURY BASALT	Basalt	Gloss Painted
WOODBURY CASHMERE	Cashmere	Gloss Painted
WOODBURY IVORY	Ivory	Gloss Painted
WOODBURY WHITE	White	Gloss Painted

\*Colour/Finish is different between F and R codes as detailed.

# RANGE PANEL SPECIFICATION

RANGE	COLOUR	FINISH
INLINE SELECT	Gloss Mussel	Gloss Painted
INLINE SELECT	Gloss Pure White	Gloss Painted
INLINE TREND	Gloss Ice Anthracite	Gloss Painted
INLINE TREND	Gloss Ice Basalt	Gloss Painted
INLINE TREND	Gloss Ice Cashmere	Gloss Painted
INLINE TREND	Gloss Ice Ivory	Gloss Painted
INLINE TREND	Gloss Ice White	Gloss Painted
INLINE TREND	Gloss Diamond Dakar	Gloss Acrylic
INLINE TREND	Gloss Diamond Grey	Gloss Acrylic
INLINE TREND	Gloss Diamond White	Gloss Painted
INLINE TREND	Ivory	Matt Lacquered MFC
INLINE TREND	White	Matt Lacquered MFC
INLINE FORM	Matt Avola Champagne	Matt MFC
INLINE FORM	Matt Avola Grey	Textured Matt MFC
INLINE FORM	Matt Avola Ivory	Matt MFC
INLINE FORM	Matt Avola White Ash	Matt MFC
INLINE FORM	Matt Cashmere Textured	Matt MFC Grained
INLINE FORM	Matt Dark Oak Textured	Textured Matt MFC
INLINE FORM	Matt Light Ash Textured	Textured Matt MFC
INLINE FORM	Matt Mussel Textured	Matt MFC Grained
INLINE FORM	Matt Porcelain Textured	Matt MFC Grained
INLINE FORM	Matt Stone Textured	Matt MFC Grained
INLINE FORM	Matt White	Matt MFC

# RECOMMENDED PILASTERS



## STAINLESS STEEL PILASTER

	All Ranges
<b>PIL1087SL</b> 870MM	Stainless Steel



## COLLARED PILASTER

	Edmonton	Newport
<b>CPIL1010</b> 100x1046mm		
<b>CPIL1023</b> 100x2276mm	Ivory	Ivory
<b>CPIL1013</b> 100x1366mm		



## CHUNKY PILASTER

	Austin
<b>CHPIL1010</b> 100x900mm	
<b>CHPIL1023</b> 100x2276mm	Painted Ivory
<b>CHPIL1013</b> 100x1366mm	



# RECOMMENDED CORNICE, PELMET & DECORATIVE PLINTH

## GENERIC CORNICE AND PELMET CODES

Generic codes are available that will allocate the recommended cornice or pelmet style automatically to each range.

	Frontal co-ordinated	Cabinet matched code
Cornice	CORF*	CORC
Pelmet	PELF*	PELC

\* Specifications match the Range Panel Specification on p49, except for Newport and Hacienda which are supplied cabinet matched.

## UNIVERSAL CORNICE AND PELMET

DIMENSIONS:  
3000mm x 40mm



Alta Mussel	Alta Pure White	Boston Ivory	Boston White	Orlando White	Orlando Dakar
CORPEL30ZZ Gloss Mussel	CORPEL30ZZ Gloss White	CORPEL30ZZ Gloss Ivory	CORPEL30ZZ Gloss White	CORPEL30ZZ Gloss White	CORPEL30ZZ Gloss Dakar

Orlando Grey	Salerno Ivory	Salerno White	Westport Ivory	Westport White	Woodbury Anthracite
CORPEL30ZZ Gloss Grey	CORPEL30ZZ Gloss Ivory	CORPEL30ZZ Gloss White	CORPEL30WS Painted Ivory	CORPEL30WS Painted White	CORPEL30ZZ Gloss Anthracite

Woodbury Basalt	Woodbury Cashmere	Woodbury Ivory	Woodbury White	Cabinet Matched (Available in all ranges)
CORPEL30ZZ Gloss Basalt	CORPEL30ZZ Gloss Cashmere	CORPEL30ZZ Gloss Ivory	CORPEL30ZZ Gloss White	CORPEL30 Ivory, Oak, Pear, Walnut, White

Cabinet matched specification - CORPEL30 available for all ranges.  
Frontal co-ordinated specification - CORPEL supplied as detailed.

## MODERN TANGENT MDF CORNICE AND PELMET

DIMENSIONS:  
3000mm x 45mm



DIMENSIONS:  
3000mm x 55mm



Calgary White	Cranbrook Ivory	Cranbrook Platinum	Cranbrook Sage	Cranbrook Stone	Georgia Oak
CORT30P/UPST30P White	CORT30V/UPST30V Ivory	CORT30V/UPST30V Platinum	CORT30V/UPST30V Sage	CORT30V/UPST30V Stone	CORT30P/UPST30P Oak

Georgia Walnut	Newport	Oakham	Salerno Ivory	Salerno White
CORT30P/UPST30P Walnut	CORT30P/UPST30P Ivory	CORT30P/UPST30P Oak	COR30P/UPS30P Gloss Ivory*	COR30P/UPS30P Gloss White*

\* Medium gloss MFC finish. These items complement but do not match high gloss front of Salerno doors. Profile is Modern Tangent.

# RECOMMENDED CORNICE, PELMET AND DECORATIVE PLINTH

## TRADITIONAL MDF CORNICE AND PELMET

DIMENSIONS:  
3000mm x 55mm



DIMENSIONS:  
3000mm x 55mm



Newport	Oakham
COR30P / UPS30P Ivory	CORT30P/UPST30P Oak

## MODERN TANGENT VENEERED CORNICE AND PELMET

DIMENSIONS:  
3000mm x 45mm



DIMENSIONS:  
3000mm x 55mm



Austin	Oakham
CORT30V/ UPST30V Painted Ivory	CORT30V/ UPST30V Oak

## SQUARE UNIVERSAL CORNICE AND PELMET\*

DIMENSIONS:  
2800mm x 38mm



Colorado	Kansas	Minnesota	Plaza Cashmere	Plaza Mussel	Plaza Porcelain
CORPEL30F Dark Oak	CORPEL30F Light Ash	CORPEL30F Avola Grey	CORPEL30F Matt Cashmere	CORPEL30F Matt Mussel	CORPEL30F Matt Porcelain

Plaza Stone
CORPEL30F Matt Stone

## DECORATIVE PLINTH

DIMENSIONS:  
3000mm x 146mm

Austin	Oakham	Aluminium Effect Plinth
DECLINTH30 Painted Ivory	DECLINTH30 Oak	DECLINTH3AU Aluminium Effect

# FINISHING TOUCHES

## SPICE DRAWERS AND SHELVES

### Spice Drawer

Set of three for 500mm dresser cabinets.  
Beech drawer. Frontal available in melamine cabinet colours.

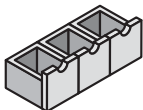

Code  
**SPICE5**

Beech

### Spice Drawer

Single for 500mm dresser cabinets.  
Beech drawer with ranged drawer front.

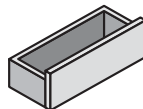

Code  
**SPICE1**

Beech

### Spice Drawer

For 150mm wide Spice/Wine Rack Cabinets.  
Beech drawer. Frontal available in melamine cabinet colours.



Code  
**SPICE15**

Beech

### Floating Shelves

Shelf pre-routed to accept the supplied concealed shelf support brackets. 10KG per shelf weight limit. Wall should be reinforced to support the shelves.



Code  
**FLSH6**  
**FLSH9**

Width

600 x 300 x 38mm  
900 x 300 x 38mm

### Shelving Panel

Available in melamine cabinet colours.



Code

Dimensions  
2600x352x18mm

**SHPANEL2618C**

### Shelf Bracket

Height: 121mm  
Depth: 108mm  
Width: 32mm

Adjustable. Max shelf thickness 30mm. Use one bracket every 600mm.



Code

**BRKDECSH**

### Arrow Shelf Bracket

Height: 108mm  
Depth: 180mm  
Width: 18mm

Adjustable. Max 40mm shelf thickness.

Use one bracket every 600mm.



Code

**SHELFBRKSS**

# FINISHING TOUCHES

# FILLER PANELS, INTERNAL BASE PANELS, PLINTHS & ACCESSORIES

## MFC Back Panel

Available in melamine cabinet colours.  
MFCBP1287P has a white reverse.

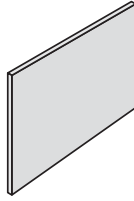

Dimensions	Code
1800x920mm 18mm Thick	<b>BBBP1892C</b>
650x920mm 18mm Thick	<b>BBU6592C</b>
1200x870mm 15mm Thick	<b>MFCBP1287P</b>

## MFC Panels

Available in melamine cabinet colours.



Dimensions	Code
650x920mm 18mm Thick	<b>BBU6592C</b>
2400x750mm 18mm Thick	<b>BLU7523C</b>
720x300mm x 15mm Thick	<b>BSP372P</b>
970x352mm x 18mm Thick	<b>BWU390C</b>

## 40mm PVC-edged Square Cut Cabinet Blender

Available in melamine cabinet colours

Laminated two sides, edged on four sides.

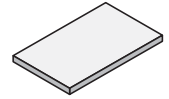

Dimensions	Code
650x900mm	<b>CMB406590</b>
900x900mm	<b>CMB400990</b>
150x2700mm	<b>CMB402715</b>
350x1000mm	<b>CMB401035</b>
350x2700mm	<b>CMB402735</b>
650x2700mm	<b>CMB402765</b>

## Tray Space

Available in melamine cabinet colours.

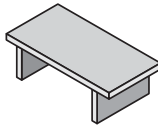

Width	Code
300mm x 570mm x 15mm Thick	<b>TSP3X6P</b>

## Plinth

Available in melamine cabinet colours.

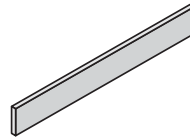

Length x Height	Code
2600x200mm	<b>CONPLINT262C</b>
2600x146mm	<b>CONPLINTHC</b>
650x200mm	<b>RETPLINTH652</b>

## Plinth Connector

Pair.  
Available in melamine cabinet colours.

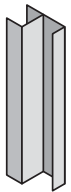

Height	Code
146mm	<b>BRKPLINTH</b>
200mm	<b>BRKPLINTH200</b>

## Plinth Seal

Length: 2600mm

Included in CONPLINTHC/RF codes.

CONPLINTHS for use with cabinet matched CONPLINTH and CONPLINTH262.

PLINTHS18 for use with frontal matched plinths, DECPLINTH30 and DECPLINTH3AU.

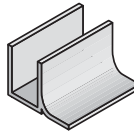

Width	Code
15mm	<b>CONPLINTHS</b>
18mm	<b>PLINTHS18</b>

## Edging Tape

Size is range specific.



Code
<b>EDGESTRIPF</b> (Frontal Co-ordinated)
<b>EDGESTRIPR</b> (Replacement End Co-ordinated)
<b>EDGESTRIPC</b> (Cabinet Matched)

## Edging Tape

**EDGESTRIP14** available in Austin, Boston, Cranbrook, Orlando and Salerno.

**EDGESTRIP2210** available in Cabinet colours.

**EDGESTRIP221F** available in Colorado, Hacienda, Kansas, Minnesota and Plaza.

**EDGESTRIP24** available in Alta, New York and Woodbury.



Width	Code
1.4m (22mm)	<b>EDGESTRIP14</b>
10m (22mm)	<b>EDGESTRIP2210</b>
10m (22mm)	<b>EDGESTRIP221F</b>
2.4m (25mm)	<b>EDGESTRIP24</b>

# FINISHING TOUCHES

## GLASS SHELVING. GLASS & LAMINATE SPLASHBACKS & UPSTANDS.

**Frosted Glass Shelf**  
Depth: 247mm

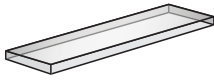

Width	Code
600mm	GLSHELF6F
800mm	GLSHELF8F
1000mm	GLSHELF10F

**Glass Shelf Deco Bracket**  
For use with Frosted Glass Shelves

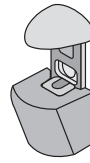

Code
BRKDECGLSH

**Illuminated Aluminium Glass Shelf**  
Depth: 200mm

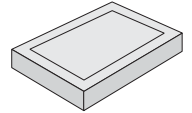

Width	Code
600mm	IGLSHELF6AU

**Coloured Glass Splashback**  
Height: 750mm  
Toughened glass. Cannot be cut.  
See page 17 of General Information for colour options.



Width	Code
595mm	GLSPLASH675
795mm	GLSPLASH875
895mm	GLSPLASH975

**Coloured Glass Upstand**  
Height: 140mm  
Pack of two.  
Non-toughened glass. Can be cut.  
See page 17 of General Information for colour options.



Width	Code
1000mm	GLUP1014

**Stainless Steel Splashback**  
Height: 750mm  
Thickness: 1mm  
Supplied with optional 6mm back board to align with tiling.

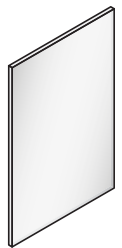

Width	Code
600mm	SBACK675
700mm	SBACK775
900mm	SBACK975

**Stainless Steel Splashback**  
Height: 750mm  
Thickness: 15mm



Width	Code
600mm	EFB675X
900mm	EFB975X

**Laminate Worktop Splashback**  
Thickness: 9mm  
Available in all 40mm and 22mm laminate worktops.  
See pages 20-21 for colour options.  
750mm high splashbacks for use behind hobs.



Width	Code
<b>22mm Worktop Finishes</b>	
3000x600mm	WT22SB30X6
600x750mm	WT22SB60X75
<b>40mm Worktop Finishes</b>	
3000x600mm	WTSB30X6
600x750mm	WTSB60X75

**Laminate Splashback Accessories**  
Available in Black or Silver.  
Compatible with all 22mm and 40mm laminate splashback finishes.

	Code
End Cap	WTSBACKEND
Butt Joint	WTSBACKBUT
Corner Joint	WTSBACKCNR

**Postformed Worktop Upstand**  
Depth: 12mm

See page 20-21 for colour options.  
Available in all 40mm and 22mm laminate worktop finishes.



Dimensions	Code
<b>22mm Worktop Finishes</b>	
95x3000mm	PF22UP3095
145x3000mm	PF22UP30145
<b>40mm Worktop Finishes</b>	
95x3000mm	PFUP3095
145x3000mm	PFUP301452

**Worktop Edging**

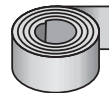

Length		Code
3m	40mm standard and premium laminate	WTEDG4
3m	22mm PVC	EDGSTRI30
4.5m	40mm standard PVC	EDGSTRI45

# FINISHING TOUCHES

# WORKTOPS, WORKTOP BLENDERS & WORKTOP ACCESSORIES

## Bullnose Worktops

See page 20 for colour options.

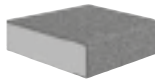

Dimensions	Code
Height 40mm Depth: up to 600mm Max Length: 4060mm	<b>PF40</b>
Height 40mm Depth: 601-900mm Max Length: 3550mm	<b>PF40</b>

## Double Bullnose Worktops

See page 20 for colour options.



Dimensions	Code
Height 40mm Depth: 655mm Max Length: 4060mm	<b>DP40</b>
Height 40mm Depth: 900mm Max Length: 3600mm	<b>DP40</b>

## PVC Edged Worktops

See page 20 for colour options.

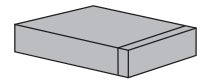

Dimensions	Code
Height 40mm Depth: up to 600mm Max Length: 4020mm	<b>PV40</b>
Height 40mm Depth: 601-900mm Max Length: 3550mm	<b>PV40</b>

## Double PVC Edged Worktops

See page 20 for colour options.

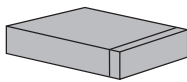

Dimensions	Code
Height 40mm Depth: up to 600mm Max Length: 4020mm	<b>DV40</b>
Height 40mm Depth: 601-900mm Max Length: 3550mm	<b>DV40</b>

## 40mm PVC-edged Square Cut Worktop Blender

Laminated two sides, edged on four sides.

See page 20 of General Information for colour options.

Available in 40mm standard worktops only.

Not available in 40mm premium laminate worktops.



Dimensions	Code
650x900mm	<b>CVB406590</b>
900x900mm	<b>CVB400990</b>
150x3000mm	<b>CVB403015</b>
350x1000mm	<b>CVB401035</b>
350x3000mm	<b>CVB403035</b>
650x3000mm	<b>CVB403065</b>

## Premium Worktops with 3mm Radius Edge

See page 21 for colour options.

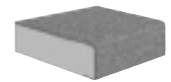

Dimensions	Code
Height 40mm Depth: up to 600mm Max Length: 3550mm	<b>PR40</b>
Height 40mm Depth: up to 870mm Max Length: 3550mm	<b>PR40</b>

## Double Premium Worktops with 3mm Radius Edge

See page 21 for colour options.



Dimensions	Code
Height 40mm Depth: 900mm Max Length: 3600mm	<b>DR40</b>

## 22mm PVC-edged Worktops

See page 21 for colour options.

22mm laminate worktops with 1mm PVC edging. Laminated both sides.



Dimensions	Code
Height 22mm Depth: up to 900mm Max Length: 3000mm	<b>PV22</b>

## 22mm Double PVC-edged Worktops

See page 21 for colour options.

22mm laminate worktops with 1mm PVC edging. Laminated both sides.



Dimensions	Code
Height 22mm Depth: up to 900mm Max Length: 3000mm	<b>DV22</b>

## 22mm PVC-edged Worktop Blenders

Available in 22mm worktops only.

See page 21 for colour options.

22mm laminate worktops with 1mm PVC edging. Laminated both sides.



Dimensions	Code
920x650mm	<b>CVB226592</b>
970x352mm	<b>CVB223597</b>
2400x750mm	<b>CVB227524</b>
920x900mm	<b>CVB22992</b>
900x1200mm	<b>CVB221292</b>
900x1800mm	<b>CVB221892</b>
900x2400mm	<b>CVB222492</b>
2400x352mm	<b>CVB222435</b>
2400x150mm	<b>CVB222415</b>

## Mason Mitre Worktop Connecting Bolt Pack

Pack of 3.

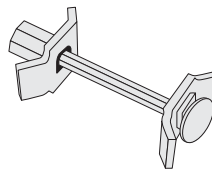

Dimensions	Code
40mm worktops	<b>MASONPACK</b>
22mm worktops	<b>WTCONBOLT22</b>

## Bullnose Worktop End Caps and Joint Strips

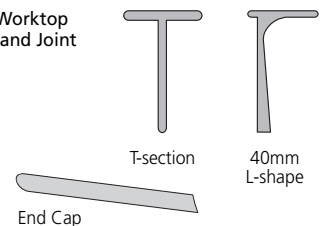

Dimensions	Code
40mm T-section (Aluminium, Black, Brown)	<b>STRIPALT4010</b>
40mm L-shape (Aluminium, Black, Brown)	<b>STRIPALP4010</b>
40mm End Cap (Aluminium, Black, Brown)	<b>STRIPALS4010</b>
40mm PVC Worktop End Cap (Aluminium)	<b>STRIPALP4064</b>

# FINISHING TOUCHES

# WORKTOP ACCESSORIES

**22mm Worktop Blanco Sink Clips**  
To replace standard sink clips.  
Pack of 10.



Code \_\_\_\_\_  
**BL453648**

**Angled Breakfast Bar Leg Light Grey**  
Max weight 150KG. With solid surface worktops use one leg per m2 worktop overhang.

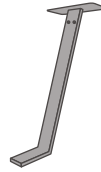

Code \_\_\_\_\_  
**LEGBARANGLE**

**Breakfast Bar Chrome Leg**  
60mm Diameter.  
870mm High.



Code \_\_\_\_\_  
**LEGBARCX**

**Breakfast Bar White Leg**  
60mm Diameter.  
870mm High.



Code \_\_\_\_\_  
**LEGBAR**

**Worktop Mounting Bar**

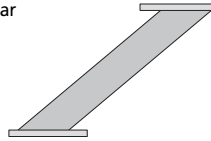

Code \_\_\_\_\_  
**WTMOUNTBAR**

# FINISHING TOUCHES

# DRAWER ACCESSORIES

## Supra Drawer Box Cream Cutlery Tray

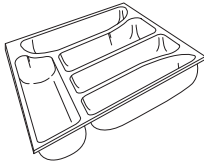

Width	Code
400mm 3 compartments	<b>CTRAYSUPR4V</b>
450mm 4 compartments	<b>CTRAYSUPR45V</b>
500mm 4 compartments	<b>CTRAYSUPR5V</b>
600mm 5 compartments	<b>CTRAYSUPR6V</b>

## Revo Drawer Box Metallic Cutlery Tray

For use with 800mm, 900 or 1000mm wide three drawer cabinet and two drawer cabinet with internal top drawer.

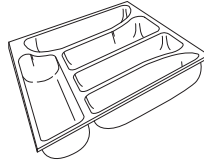

Width	Code
800mm 7 compartments	<b>CTRAYGALL8V</b>
900mm 8 compartments	<b>CTRAYGALL9V</b>
1000mm 9 compartments	<b>CTRAYGALL10V</b>

## Revo Drawer Box Metallic Cutlery Tray

For use with internal drawer units.

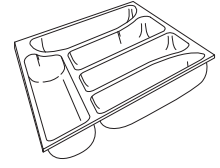

Width	Code
400mm (For use with BU456F4ID)	<b>CTRAYG4VINT</b>
450mm (For use with BU56F4ID & BU56F3IDC)	<b>CTRAYG45VINT</b>
550mm (For use with BU66F4ID & BU66F3IDC)	<b>CTRAYG55VINT</b>
600mm (For use with BU66F2ID)	<b>CTRAYG6VINT</b>

## Aluminium Cutlery Tray

For use with 800, 900 or 1000mm wide three drawer cabinet and two drawer cabinet with internal top drawer.

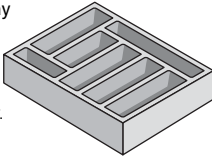

Width	Code
800mm	<b>CTRAYGALL8M</b>
900mm	<b>CTRAYGALL9M</b>
1000mm	<b>CTRAYGALL10M</b>

## Aluminium Cutlery Tray

For use with internal drawer units.

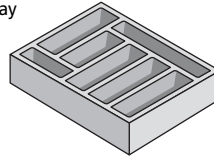

Width	Code
400mm (For use with BU456F4ID)	<b>CTRAYG4MINT</b>
450mm (For use with BU56F4ID & BU56F3IDC)	<b>CTRAYG45MINT</b>
600mm (For use with BU66F2ID)	<b>CTRAYG6MINT</b>

## Luxury Beech Cutlery Tray

For use with Revo internal drawer only.

800mm for use with Revo 800mm wide three drawer cabinet and two drawer cabinet with internal top drawer.

Special order item. Allow 4-6 weeks for delivery.

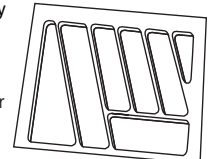

Width	Code
500mm	<b>CTRAY5PK</b>
600mm	<b>CTRAY6PK</b>
800mm	<b>CTRAY8PK</b>

## Internal Drawer for Cupboards and Larders

Additional Revo internal drawer.

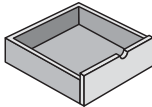

Width	Code
300mm	<b>IDWBU3</b>
400mm	<b>IDWBU4</b>
450mm	<b>IDWBU45</b>
500mm	<b>IDWBU5</b>
600mm	<b>IDWBU6</b>

## Internal Deep Drawer for Cupboards and Larders

Additional Revo internal drawer.

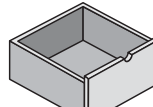

Width	Code
300mm	<b>IDDWBU36</b>
400mm	<b>IDDWBU46</b>
450mm	<b>IDDWBU456</b>
500mm	<b>IDDWBU56</b>
600mm	<b>IDDWBU66</b>

## Internal Drawer for Two Pan Drawers

Additional Revo internal drawer.

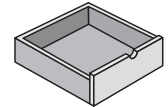

Width	Code
800mm	<b>IDWPD8</b>
900mm	<b>IDWPD9</b>



# FINISHING TOUCHES

# DRAWER ACCESSORIES

### 500mm Beech Utensil Tray

For use with 800mm, 900 or 1000mm wide three drawer cabinet and two drawer cabinet with internal top drawer.

Contents: Bottle Opener, Can Opener, Corkscrew, Fruit Baller, Garlic Press, Ice Cream Scoop, Lemon Zester, Pastry Cutter, Potato Peeler.

Special order item. Allow 4-6 weeks for delivery.

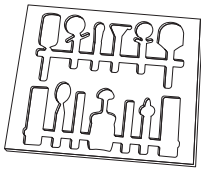

Width	Code
500mm	UTRAY5

### 600mm Beech Utensil Tray

For use with 800mm, 900 or 1000mm wide three drawer cabinet and two drawer cabinet with internal top drawer.

Contents: Bottle Opener, Can Opener, Cheese Grater, Cheese Slice, Corkscrew, Fruit Baller, Garlic Press, Ice Cream Scoop, Pastry Cutter, Pizza Cutter, Potato Fork, Potato Peeler.

Special order item. Allow 4-6 weeks for delivery.

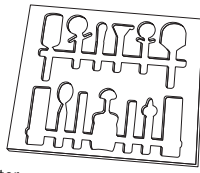

Width	Code
600mm	UTRAY6

### 800mm Beech Utensil Tray

For use with 800mm, 900 or 1000mm wide three drawer cabinet and two drawer cabinet with internal top drawer.

Contents: Apple Corer, Bottle Opener, Cake Server, Can Opener, Cheese Grater, Cheese Slice, Corkscrew, Fruit Baller, Garlic Press, Ice Cream Scoop, Lemon Zester, Mezzaluna.

Special order item. Allow 4-6 weeks for delivery.

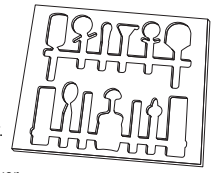

Width	Code
800mm	UTRAY8

### Drawer Mat

For use with Revo internal and deep pan drawers only.

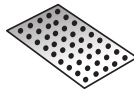

Width	Code
300mm	DWMAT3
400mm	DWMAT4
450mm	DWMAT45
500mm	DWMAT5
550mm	DWMAT5
600mm	DWMAT6
800mm	DWMAT8
900mm	DWMAT9
1000mm	DWMAT10

### Pan Drawer Divider Kit

For use with Revo deep pan drawers only.

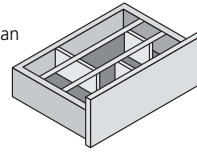

Width	Code
800mm	DWDIVGALL8

### Beech Plate Stack

For use with Revo deep pan drawers only.

Contents: 8 Wooden Dowels and 1 Base Board for up to 900mm (W). 10 Wooden Dowels and 1 Base Board for 1000mm (W) only.

Special order item. Allow 4-6 weeks for delivery.

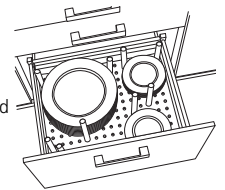

Dimensions	Code
800x276mm	PDPLATESTK8
900x276mm	PDPLATESTK9
1000x276mm	PDPLATESTK10

### Aluminium Pan Organiser

For use with Revo deep pan drawers only.

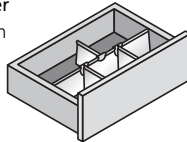

Width	Code
800mm	DW470RG8
900mm	DW470RG9
1000mm	DW470RG10

### Orgaflag Drawer Management

For use with Revo deep pan drawers only.

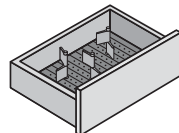

Width	Code
800mm	ORGAFLAG8
900mm	ORGAFLAG9
1000mm	ORGAFLAG10

### Orgastore Drawer Management

For use with Revo deep pan drawers only.

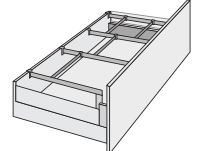

Width	Code
800mm	ORGASTORE8
900mm	ORGASTORE9
1000mm	ORGASTORE10

### Flip-out Pan Drawer Storage

Pack of two.

Chrome effect plastic.

For use with Revo deep pan drawers only.

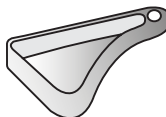

Code
ORGAWING

# FINISHING TOUCHES

# CABINET STORAGE ACCESSORIES

## Two Tier Bottle Rack

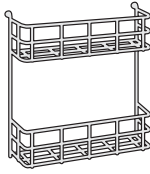

Height x Width x Depth	Code
400x382x100mm	DOORBASKTCH

## Single Tier Bottle Rack

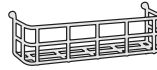

Height x Width x Depth	Code
100x382x100mm	DOORBASKSCH

## Chrome Wine Rack Shelf

Open display units only.

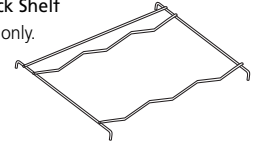

Width	Code
300mm Cabinet	WRSHELF3CX
500mm Cabinet	WRSHELF5CX

## Wine Glass Rack (Two Columns)

Min 300mm Wall Cabinet.

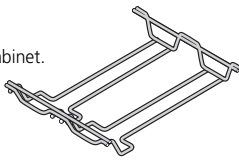

Code
GLASSCOL2

## Chrome Pull-out Larder Baskets

300mm Larder Cabinets only.

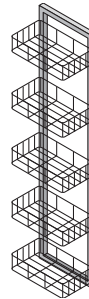

Code
PLUBASKCX

## Angled Chrome Pull-out Basket

45° Base Cabinet only.

Pack consists of runner, brackets and two baskets.

Please state handing when ordering, left hand shown.

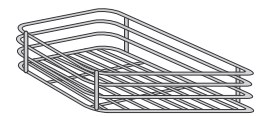

Height x Width	Code
75x470mm	DPLBASK45

## ½ Carousel Basket

Pair.

For use with 1000mm Corner Base with 500mm door (CB106FA/DA) and 1200mm corner base with 600mm door (CB126FA/DA). Order units separately.

Diameter 850mm.

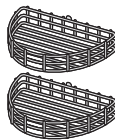

Code
CAROBASKCH

## ¾ Chrome Carousel Basket

Diameter 700mm



Code
CAROBASKCX

## Chrome Basket with Runners

Depth 450mm

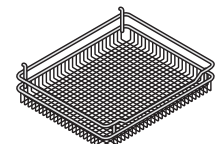

Width	Code
500mm Cabinet	PBASK5CX
600mm Cabinet	PBASK6CX

## Le Mans Pull-out for Corner Base Cabinets

Handing required.

For use with 1000mm Corner Base with 500mm Door. To be installed in CB106DA/FA (ordered separately).

For corner cabinet with a door on the left hand side, order left handing, vice versa for right.

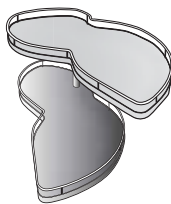

Code
LEMANSKU

## Magic Corner

Handing required.

To be installed in CB106DA/FA (ordered separately). For corner cabinet with a door on the left hand side, order left handing, vice versa for right.

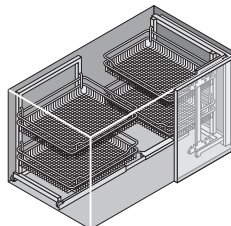

	Code
Left Hand	MCULCX
Right Hand	MCURCX

## Wicker Basket

Pack of 2 comes with Runners

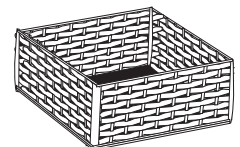

Width	Code
500mm Cabinet	WICKBASK

# FINISHING TOUCHES

# CABINET STORAGE ACCESSORIES & WASTE DISPOSAL

### iMove Pull Down Basket

For easy access to wall cabinets  
724 and 900mm high units only.

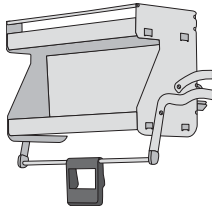

Width	Code
500mm	<b>IMOVE5</b>
600mm	<b>IMOVE6</b>

### 30-Litre Ecobin

Contains three 10 litre bins.  
Height - 422mm  
Depth - 480mm  
Minimum Cabinet:  
110° hinge - 300mm cabinet  
170° hinge - 400mm cabinet

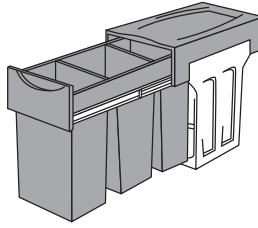

Code	<b>ECOBIN3X10</b>
------	-------------------

### 40-Litre Ecobin

Contains one 20-Litre and two 10-Litre Bins  
Height - 422mm  
Depth - 480mm  
Minimum Cabinet:  
110° hinge - 400mm cabinet  
170° hinge - 500mm cabinet

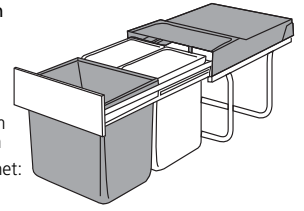

Code	<b>ECOBIN4</b>
------	----------------

### 60-Litre Ecobin

Contains one 34-Litre and two 17-Litre Bins  
Height - 540mm  
Depth - 492mm.  
Full height units only.  
600mm Cabinet.

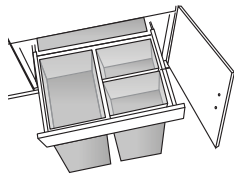

Code	<b>ECOBIN60L</b>
------	------------------

### Deluxe Chrome Swing Bin

Min 400mm Cabinet.  
Contains one 12-Litre Bin.  
Do not use with 170° hinge.  
Height: 280mm.  
Diameter 260mm.

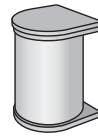

Code	<b>SWINGBINCH</b>
------	-------------------

### Triple Recycling Bin

500mm/600mm Cabinet.  
Contains one 19-Litre, one 12-Litre and one 9-Litre Bin.  
Do not use with 170° hinge.  
Height - 525mm  
Depth - 450mm

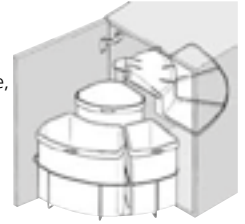

Code	<b>RECYCLEBIN</b>
------	-------------------

# FINISHING TOUCHES FITTINGS

**Ventilation Grill**  
Flow rate: 200cm<sup>2</sup>

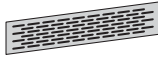

Dimensions	Code
80x550mm	VENTGRILL200

**Replacement Leg**  
Pack of four.

Code
LEG15

**Decorative Leg**  
Pack of four.  
Chrome effect plastic.

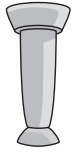

Height	Code
100mm	ADJCHRLEG

**Double Towel Rail**

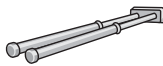

Depth	Code
430mm	METALTRAIL

**Sink Cabinet Liner**

800, 900 and 1000 sink liners can only be used in corner base units if the centre post is in the middle of the unit.

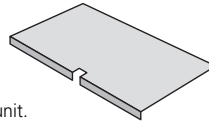

Width	Code
500mm	SU5LINER
600mm	SU6LINER
800mm	SU8LINER
900mm	SU9LINER
1000mm	SU10LINER
1200mm	SU12LINER

**Frontal Connecting Brackets**

Pack of two.

Code
BRKLCB

**What Lock**

Magnetic lock system 2 x locks per pack



Code
MAGLOCK

**Baton Support Pack**

Backboard support is used to fit wall units flush with adjacent tall units.

Includes a white MFC back panel and two uprights. A frontal matched blender panel should be ordered separately to run underneath the units.

Maximum wall unit run is 2400mm wide.



	Code
560 Wall Units	BACKBAT56
724 Wall Units	BACKBAT72
900 Wall Units	BACKBAT90

**Soft Close Hinge Buffers**

Clip on hinge buffers.



	Code
110° Hinge (Pack of 5)	SOFTCLOSE5
110° Hinge (x1)	SMOVE1110
170° Hinge (x1)	SOFTCL1170
45° Unit (x1)	FPK903
St. Steel Glazed Units (x1)	SOFTCLOSEGL

# LIGHTING

The importance of lighting in completing a welcoming attractive kitchen design cannot be underestimated. A full selection of low energy LED lighting and accessories is available to help you achieve this. The range includes spotlights, flexible strip light, illuminated shelves, sensor switches to turn lights off and on when cupboards open and dimmer controls.



1. LED Strip Lights  
Available in 250mm, 330mm and 550mm sizes.



2. HD LED Spot Light  
Available in cool or warm white light.



3. HD LED Square Light  
Available in cool or warm white light.



4. LED Flat Disc Light  
Surface mounted thin 6mm deep light. Available in a warm white light.



5. Plinth Lights  
Available in cool or warm white light.



6. Quadra Under Cabinet Light  
Available in cool or warm white light and with optional on/off sensor.

# FINISHING TOUCHES

## POP UP SOCKETS & LIGHTING

### Replacement Bulb

For illuminated shelving, see page 56.

Code

REPULB287 (For 600mm IGLSHELF6AU)

REPULB516 (For 1200mm IGLSHELF12AU)

### Pop Up Socket

Three plug sockets and two USB ports.

Installation hole 90-92mm. Supplied with 2.5m long cable.



Code

POPUSOCKU

### EVoline® Pop Up Socket

Three plug sockets and two USB ports.

Premium flush finished stainless steel top.

Installation hole 102mm. Supplied with 3m long cable.



Code

POPUSOCKUSS

### LED Plinth Lights

Four lights/ 1.5m cable.

Driver included – maximum allowance of 4w (x22 lights).

Not suitable in front of appliances.



Wattage

Code

0.72w Cool White

LEDSQPLINTCW

0.72w Warm White

LEDSQPLINTWW

### LED Pan Drawer Light

12V, order driver(s) separately POWDRIVE15.



Width

Wattage

Code

800mm

4.5w

PDLIGHT8

900mm

5.4w

PDLIGHT9

1000mm

5.4w

PDLIGHT10

### 12v/15w Pan Drawer Light Driver

Combined wattage of connected lights must not exceed driver wattage.

Code

POWDRIVE15

### HD Spotlight

Surface mounted or recessed.

Order driver separately LEDHDTFORM6.

Supplied with 2.5m cable.



Wattage

Code

1.65w Cool White

LEDSURFHD

1.65w Warm White

LEDSURFHDWW

### HD Square Light

Surface mounted.

Order driver separately LEDHDTFORM6.

Supplied with 2.5m cable.



Wattage

Code

1.8w Cool White

LEDSQSURFHD

1.8w Warm White

LEDSQSURHDWW

### HD 24v Driver

Six connections.

Combined wattage of connected lights must not exceed driver wattage.

Supplied with 1.5m driver connection cable.



Wattage

Code

15w

LEDHDTFORM6

### LED Flat Disc Light

Surface mounted thin 6mm deep light.

Cable length 1.5m

Order driver separately LEDTFORMER6.



Wattage

Code

1.5w Warm White

LEDFLATDWW

### LED Orbit Bright Tilt Light

Order driver separately LEDTFORMER6.

Supplied with 1.5m cable.



Wattage

Code

3w Cool White

LEDORBITCW

3w Warm White

LEDORBITWW

### 12v/15w Driver

Six power ports.

Combined wattage of connected lights must not exceed driver wattage.



Code

LEDTFORMER6

# FINISHING TOUCHES LIGHTING

## HD Delta Light

Order driver separately LEDHDTFORM6 or upgrade to LEDHDDIMMER.  
Supplied with 2.5m cable.



Wattage	Code
1.65w Cool White	LEDELTAHD
1.65w Warm White	LEDELTAHDWW

## HD Delta Light

With on/off touch sensor.  
Can switch up to two non-sensor HD lights.  
Order driver separately LEDHDTFORM6.  
Supplied with 2.5m cable.



Wattage	Code
2.15w Cool White	LEDELTAHDS
2.15w Warm White	LEDELTHDSWW

## HD 24v Driver

Six connections.  
Combined wattage of connected lights must not exceed driver wattage.  
Supplied with 1.5m driver connection cable.



Wattage	Code
15w	LEDHDTFORM6

## Example 1

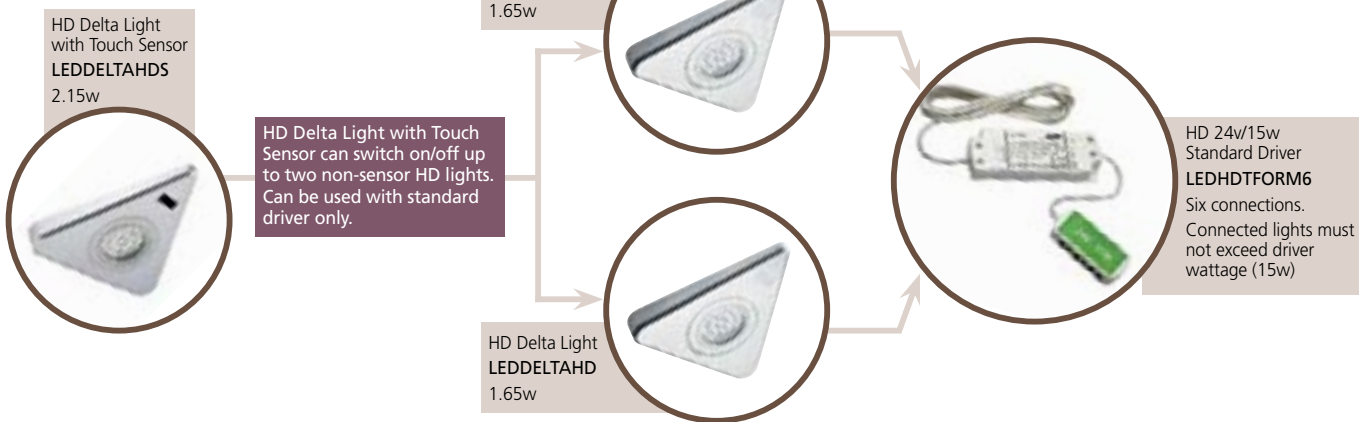

## LED Quadra Under Cabinet Light

Order driver separately LEDTFORMER6.  
Cable length 1.5m.



Wattage	Code
2.4w Cool White	LEUCABCW
2.4w Warm White	LEUCABWW

## LED Quadra Under Cabinet Light with On/Off Touch Sensor

Can switch up to five non-sensor Quadra lights.  
Order driver separately LEDTFORMER6.  
Cable length 1.5m.



Wattage	Code
2.5w Cool White	LEUCABTSCW
2.5w Warm White	LEUCABTSSWW

## 12v/15w Driver

Six power ports.  
Combined wattage of connected lights must not exceed driver wattage.



Code
<b>LEDTFORMER6</b>

## Example 2

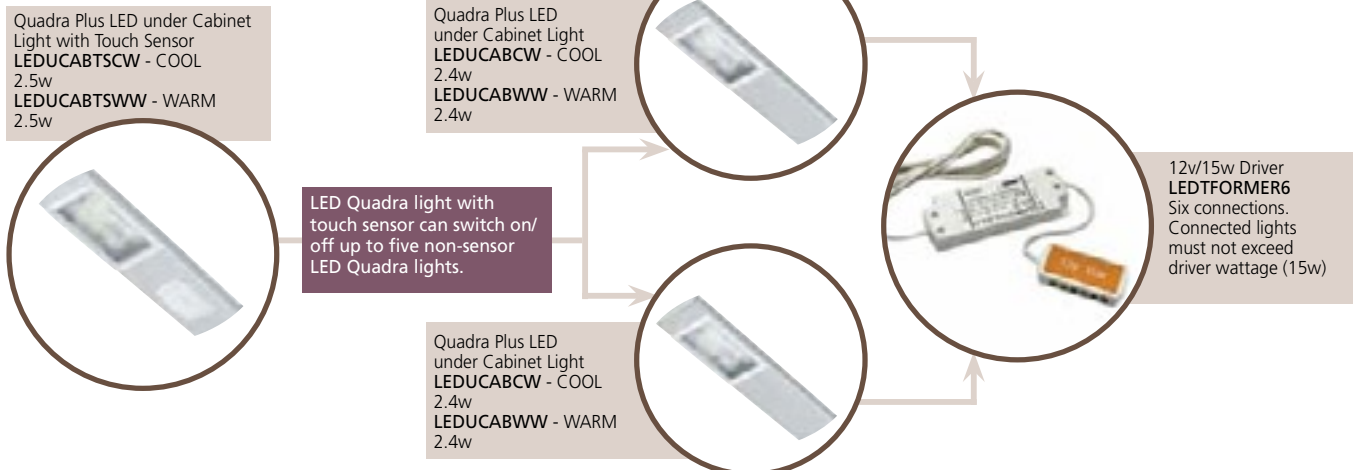

# FINISHING TOUCHES LIGHTING

## GX53 LED Triangle Light

Surface Mounted.  
Driver not required.  
Connect directly to mains.

Up to 6 lights can be connected together using a distributor block and plug (DISTRIBGX53).

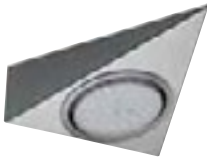

Wattage	Code
240V/3w Cool White	LEDTRICW
240V/3w Warm White	LEDTRIWW

## GX53 LED Round Light

Surface mounted or recessed.

Driver not required.  
Connect directly to mains.

Up to 6 lights can be connected together using a distributor block and plug (DISTRIBGX53).



Description	Code
240V/3w Cool White	LEDSURFACE
240V/3w Warm White	LEDSURFACEWW

## GX53 Accessories

Driver has 6 connections, 1500mm cable and 13A plug for direct mains connection.

Combined wattage of connected lights must not exceed driver wattage.



Description	Code
6 Way GX53 Distributor Block	DISTRIBGX53
Extension Cable (2000mm)	EXTCABGX53

## GX53 Accessories



Description	Code
240V/3w Replacement Bulb	LEDREPBULB

## LED 24v LED Linkable Strip Light

Can be interlinked to create longer lengths.

Order driver separately LEDHDTFORM6.



Length	Wattage	Code
400mm	4.6w Cool White	LEDLSTRIP4CW
400mm	4.6w Warm White	LEDLSTRIP4WW
600mm	7.1w Cool White	LEDLSTRIP6CW
600mm	7.1w Warm White	LEDLSTRIP6WW

## 12v/15w Driver

Six power ports.

Combined wattage of connected lights must not exceed driver wattage.



Code
LEDTFORMER6

## LED Task Strip Light

Includes 1000mm mains cable and 200mm extension cable.

Driver not required.

Each light can be linked directly together, or with the optional link cable LEDSTRIPCON.



Wattage	Code
240v/2.7w, 250mm	LEDSTRIP25
240v/4.5w, 330mm	LEDSTRIP33
240v/8w, 550mm	LEDSTRIP55

## 500mm Task Strip Light Link Cable



Code
LEDSTRIPCON

## Example 3

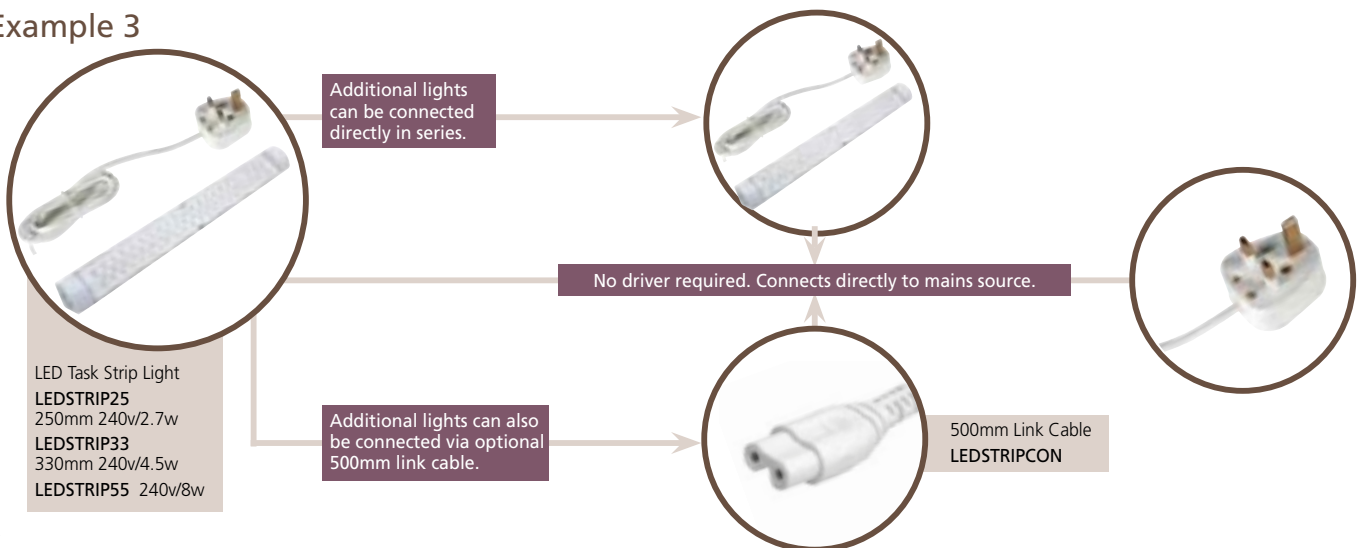



# FINISHING TOUCHES LIGHTING

## LED Flexible Strip

12v/0.8w.  
Order driver separately.  
Standard driver  
LEDTFORMFXCON.  
Can be combined with  
LEDSWITCH.  
Adhesive backing for  
easy installation.



Length	Code
300mm Cool White	LEDFLEXI3WH
300mm Blue	LEDFLEXI3BL
300mm Warm	LEDFLEXI3WW

## LED Flexible Strip

12v/5w.  
Order driver separately.  
Standard driver  
LEDTFORMFXCON.  
Can be combined with  
LEDSWITCH.  
Adhesive backing for  
easy installation.

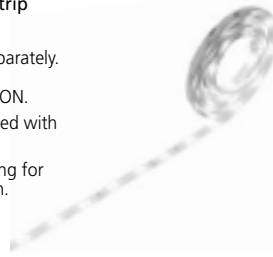

Length	Code
2000mm Cool White	LEDFLEXI2MWH
2000mm Blue	LEDFLEXI2MBL
2000mm Warm	LEDFLEXI2MWW

## Driver Connection Cable

Included with driver  
LEDTFRMFCON. Order extra  
cables to run additional LED  
flexible strip lights from  
one driver.



Length	Code
2.5m	FLEXICON

## Link Cable

Can be used to  
connect one uncut  
flexible strip light to  
another.  
Order SE10318MCC  
to connect cut  
strip lights.



Length	Code
1500mm	FLEXILINK15
500mm	FLEXILINK5
50mm Link/Corner Cable	FLEXILINK50

## Flexible Strip Connector

12mm x 8mm.  
To connect one off-cut to a  
full flexible strip light.

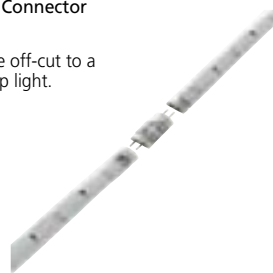

Code
SE10318MCC

## 12v/15w Driver and 2.5m Driver Connection Cable

Six power ports.  
Combined wattage  
of connected lights  
must not exceed  
driver wattage.



Code
LEDTFRMFCON

## Example 4

LED Cool White/Cool  
Blue Flexible Strips  
LEDFLEXI3WH/BL  
300mm 12v/0.8w  
LEDFLEXI2MWH/BL  
2m 12v/5w

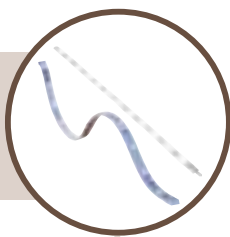

12v/15w Driver and 2.5m  
Driver Connection Cable  
LEDTFRMFCON  
Connected lights must not  
exceed driver wattage (15w)



Additional lights can be connected directly together  
in series without a link or via a 50mm link (for corner  
return) or 500/1500mm link, or 500mm link (for straight  
connection). An offcut of a flexible strip light can be  
connected once to a full flexible strip with the strip  
connector piece.

Link/Connector Cables  
50mm Corner Cable  
FLEXILINK50  
500mm Straight Cable  
FLEXILINK5  
1500mm Straight Cable  
FLEXILINK15  
12mm Flexible Strip  
Connector  
SE10318MCC

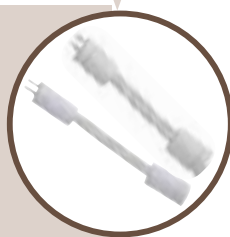

For every independent run of strip lights, a  
driver connection lead is required. Maximum  
of six per driver.



2.5m Driver  
Connection Cable  
FLEXICON

# CABINETS

Full Height Base/Sink Cabinet (cabinet only)	
Code	Description
BUC1506F	150mm Base Cabinet
BUC1503F	150mm Base Cabinet Reduced Depth
BUC36F	300mm Base Cabinet
BUC33F	300mm Base Cabinet Reduced Depth
BUC46F	400mm Base Cabinet
BUC43F	400mm Base Cabinet Reduced Depth
BUC456F	450mm Base Cabinet
BUC453F	450mm Base Cabinet Reduced Depth
BUC56F	500mm Base/Sink Cabinet
BUC53F	500mm Base Cabinet Reduced Depth
BUC66F	600mm Base/Sink Cabinet
BUC63F	600mm Base Cabinet Reduced Depth
BUC86F	800mm Base/Sink Cabinet
BUC83F	800mm Base Cabinet Reduced Depth
BUC96F	900mm Base/Sink Cabinet
BUC93F	900mm Base Cabinet Reduced Depth
BUC106F	1000mm Base/Sink Cabinet
BUC103F	1000mm Base Cabinet Reduced Depth
BUC126F	1200mm Base/Sink Cabinet
BSUC66	600mm Belfast Sink Cabinet
CBC86FA/B/C	800mm Corner Base Cabinet
CBC96FA	900mm Corner Base Cabinet
CBC106FA/B/C	1000mm Corner Base Cabinet
CBC126FA/E/F	1200mm Corner Base Cabinet
LCBC99FMAIN LCBC99LEG LPOSTCBU18	930x930 L Shaped Corner Base Cabinet. Supplied in two parts, one part RFA, one part assembled.
KDBUC3645	45 Degree Base End Cabinet

Drawer Line Base/Sink Cabinet (excludes drawer box - cabinet only)	
Code	Description
BUC1506	150mm Base Cabinet
BUC36	300mm Base Cabinet
BUC33D	300mm Base Cabinet Reduced Depth
BUC46	400mm Base Cabinet
BUC43D	400mm Base Cabinet Reduced Depth
BUC456	450mm Base Cabinet
BUC453D	450mm Base Cabinet Reduced Depth
BUC56	500mm Base/Sink Cabinet
BUC53D	500mm Base Cabinet Reduced Depth
BUC66	600mm Base/Sink Cabinet
BUC63D	600mm Base Cabinet Reduced Depth
BUC86	800mm Base/Sink Cabinet
BUC83D	800mm Base Cabinet Reduced Depth
BUC96	900mm Base/Sink Cabinet
CBC93D	900mm Base Cabinet Reduced Depth
BUC106	1000mm Base/Sink Cabinet
CBC103D	1000mm Base Cabinet Reduced Depth
BUC126	1200mm Base/Sink Cabinet
CBC86D	800mm Corner Base Cabinet
CBC96DA	900mm Corner Base Cabinet
CBC106DA/B/C	1000mm Corner Base Cabinet
CBC126DA/E/F	1200mm Corner Base Cabinet
LCBC99DMAIN LCBC99LEG LPOSTCBU18	930x930 L Shaped Corner Base Cabinet. Supplied in two parts, one part RFA, one part assembled.
KDBUC3645	45 Degree Base End Cabinet

Corner Posts 15mm	
Code	Description
RCPOSTBU	Base Unit
RCPOSTSWU56	560 Wall Unit
RCPOSTTWU72	720 Wall Unit

Corner Posts 18mm	
Code	Description
LPOSTCBU18	Base Unit
LPOSTWU7218	720 Wall Unit
LPOSTWU9018	900 Wall Unit

Drawer Line Base Cabinet (excludes drawer box – cabinet only)	
Code	Description
DUC46	400mm Base Cabinet Four Drawer
DUC56	500mm Base Cabinet Four Drawer
DUC66	600mm Base Cabinet Four Drawer
PDC56D2	500mm Base Cabinet Two Drawer
PDC66D2	600mm Base Cabinet Two Drawer
PDC86D2	800mm Base/Sink Cabinet Two Drawer
PDC96D2	900mm Base/Sink Cabinet Two Drawer
PDC56	500mm Base Cabinet Three Drawer
PDC66	600mm Base Cabinet Three Drawer
PDC86	800mm Base/Sink Cabinet Three Drawer
PDC96	900mm Base/Sink Cabinet Three Drawer
PDC106	1000mm Base/Sink Cabinet Three Drawer

Low Wall Cabinet (561mm high - cabinet only)	
Code	Description
WUC356	300mm Wall Cabinet
WUC456	400mm Wall Cabinet
WUC4556	450mm Wall Cabinet
WUC556	500mm Wall Cabinet
WUC656	600mm Wall Cabinet
WUC856	800mm Wall Cabinet
WUC956	900mm Wall Cabinet
WUC1056	1000mm Wall Cabinet
CWUC656/FB	600mm Corner Wall Cabinet
CWUC856FA	800mm Corner Wall Cabinet
CWUC956FC	900mm Corner Wall Cabinet
MWUC656	Microwave Wall Cabinet
GDOC456	400mm Glazed Wall Cabinet
GDOC556	500mm Glazed Wall Cabinet

Standard Wall Cabinet (724mm high – cabinet only)	
Code	Description
WUC15072	150mm Wall Cabinet
WUC372	300mm Wall Cabinet
WUC472	400mm Wall Cabinet
WUC4572	450mm Wall Cabinet
WUC572	500mm Wall Cabinet
WUC672	600mm Wall Cabinet
WUC872	800mm Wall Cabinet
WUC972	900mm Wall Cabinet
WUC1072	1000mm Wall Cabinet
CWUC672/FB	600mm Corner Wall Cabinet
GDOC472	400mm Glazed Wall Cabinet
GDOC572	500mm Glazed Wall Cabinet
HFWUC572	500mm Horizontal Bi-fold Cabinet
HFWUC672	600mm Horizontal Bi-fold Cabinet
HFWUC872	800mm Horizontal Bi-fold Cabinet
HFWUC972	900mm Horizontal Bi-fold Cabinet

Tall Wall Cabinet (900mm high – cabinet only)	
Code	Description
WUC390	300mm Wall Cabinet
WUC490	400mm Wall Cabinet
WUC4590	450mm Wall Cabinet
WUC590	500mm Wall Cabinet
WUC690	600mm Wall Cabinet
WUC890	800mm Wall Cabinet
WUC990	900mm Wall Cabinet
WUC1090	1000mm Wall Cabinet
CWUC690/FB	600mm Corner Wall Cabinet
GDUC590	500mm Glazed Wall Cabinet
CWUC890FA	800mm Corner Wall Cabinet
CWUC990FC	900mm Corner Wall Cabinet

Bridging Cabinet (cabinet only)	
Code	Description
OCHC536	500mm Bridging Cabinet (360mm high)
OCHC636	600mm Bridging Cabinet (360mm high)
OCHC836	800mm Bridging Cabinet (360mm high)
OCHC936	900mm Bridging Cabinet (360mm high)
OCHC63	600mm Bridging Cabinet (300mm high)
OCHC1028	1000mm Bridging Cabinet (280mm high)

Larder/Pantry Cabinet (2100mm high - excludes drawer box - cabinet only)	
Code	Description
LUC33	300mm Reduced Depth Larder Cabinet
LUC36	300mm Larder Cabinet
LUC56	500mm Larder Cabinet
LUC66	600mm Larder Cabinet
PUC662ID2	600mm Pantry Cabinet with Two Drawers
PUC662ID3	600mm Pantry Cabinet with Three Drawers
PUC662ID4	600mm Pantry Cabinet with Four Drawers
CNLUC106/C/A	1000mm Corner Cabinet
PUC106	1000mm Pantry Cabinet

Tall Larder Cabinet (2276mm high – cabinet only)	
Code	Description
LUC3623	300mm Reduced Depth Larder Cabinet
LUC3623	300mm Larder Cabinet
LUC5623	500mm Larder Cabinet
LUC6623	600mm Larder Cabinet
CNLUC10623/C/A	1000mm Larder Cabinet
PUC10623	1000mm Corner Pantry Cabinet

Oven Housing (2100mm high – cabinet only)	
Code	Description
BOHC66	Built Under Oven Housing
OHC4A	Single Oven Housing Cabinet (4)
OHC5A	Single Oven Housing Cabinet (5)
OHC6A	Single Oven Housing Cabinet (6)
OHC10*	Single Oven Housing Cabinet (10A and 10E)
OHC3A	Double Oven Housing Cabinet (3)
OHC10*	Double Oven Housing Cabinet (10B)
OHC1A	Single Oven and Microwave/Compact Housing Cabinet (1)
OHC2A	Single Oven and Microwave/Compact Housing Cabinet (2)
OHC7A	Microwave/Compact Appliance Housing Cabinet (7)
OHC10*	Microwave/Compact Appliance Housing Cabinet (10D and 10G)
OHC9A	Compact Appliance Housing Cabinet (9)
OHC10*	Compact Appliance Housing Cabinet (10C and 10F)
OHC8C	Double Oven and Microwave Housing Cabinet (8C)
OFHC66A/ND	Single Oven and Integrated Fridge Housing Cabinet (A)
OFHC66B/ND	Compact Oven and Integrated Fridge Housing Cabinet (B)

\*Include style (A-G) when ordering.

Fridge Freezer Cabinet (2100mm high – cabinet only)	
Code	Description
IFUC66A/ND	Integrated Appliance Housing Cabinet (A)
IFUC66B/ND	Integrated Appliance Housing Cabinet (B)
IFUC66C/ND	Integrated Appliance Housing Cabinet (C)
IFUC66D/ND	Integrated Appliance Housing Cabinet (D)
IFUC66G/ND	Integrated Appliance Housing Cabinet (G)

Tall Oven Housing (2276mm high – cabinet only)	
Code	Description
OHC234A	Single Oven Housing Cabinet (4)
OHC235A	Single Oven Housing Cabinet (5)
OHC236A	Single Oven Housing Cabinet (6)
OHC2310*	Single Oven Housing Cabinet (10A and 10E)
OHC233A	Double Oven Housing Cabinet (3)
OHC2310*	Double Oven Housing Cabinet (10B)
OHC231A	Single Oven and Microwave/Compact Housing Cabinet (1)
OHC232A	Single Oven and Microwave/Compact Housing Cabinet (2)
OHC237A	Microwave/Compact Appliance Housing Cabinet (7)
OHC2310*	Microwave/Compact Appliance Housing Cabinet (10D and 10G)
OHC2310*	Compact Appliance Housing Cabinet (10C and 10F)
OFHC6623C/ND	Single Oven and Integrated Fridge Housing
OFHC6623D/ND	Compact Oven and Integrated Fridge Housing

\*Include style (A-G) when ordering.

Tall Fridge Freezer Cabinet (2276mm high – cabinet only)	
Code	Description
IFUC6623B/ND	Integrated Appliance Housing Cabinet (B)
IFUC6623C/ND	Integrated Appliance Housing Cabinet (C)
IFUC6623D/ND	Integrated Appliance Housing Cabinet (D)
IFUC6623G/ND	Integrated Appliance Housing Cabinet (G)
IFUC6623J/ND	Integrated Appliance Housing Cabinet (J)
IFUC6623K/ND	Integrated Appliance Housing Cabinet (K)

Mid Height Larder/Oven/Fridge Freezer Cabinet (1381mm high – cabinet only)	
Code	Description
PDC664	600mm Four Drawer Cabinet
SOHC6613	600mm Single Oven Housing Cabinet
SOHC6613A	600mm Single Oven/Microwave Housing Cabinet
DOHC6613	600mm Double Oven Housing Cabinet
AHC6613/ND	600mm Fridge Housing Cabinet
MOHC6613D3	600mm Microwave Oven Housing Cabinet
LUC5613	500mm Larder Cabinet
LUC6613	600mm Larder Cabinet

Boiler Housing (cabinet only)	
Code	Description
KBHC572	500mm Wall (724mm) Boiler Housing Cabinet
KBHC672	600mm Wall (724mm) Boiler Housing Cabinet
KBHC590	500mm Wall (900mm) Boiler Housing Cabinet
KBHC690	600mm Tall Wall (900mm) Boiler Housing Cabinet
KBHC612	Dresser (1190mm) Boiler Housing Cabinet
KBHC613	Dresser (1366mm) Boiler Housing Cabinet
KBHC615	Dresser (1560mm) Boiler Housing Cabinet

Dresser (1190mm high – cabinet only)	
Code	Description
WDUC512	500mm Worktop Dresser Cabinet
WDUSPACER5	10mm Worktop Dresser Spacer Panel

Tall Dresser (1336mm high – cabinet only)	
Code	Description
WDUC513	500mm Worktop Dresser Cabinet
WDUSPACER5	10mm Worktop Dresser Spacer Panel

# FRONTALS

	Size	Code	
720mm Wall/Full Height Frontal	150mm	KDRFH15	
	300mm	KDRFH3	
	400mm	KDRFH4	
	450mm	KDRFH45	
	500mm	KDRFH5	
	600mm	KDRFH6	
720mm Dummy Drawer and Door For LSB99D	300mm	KDRDDL3	
	400mm	KDRDDL4	
896mm Tall Wall Cabinet Frontal	300mm	KDRW63	
	400mm	KDRW64	
	450mm	KDRW645	
	500mm	KDRW65	
	600mm	KDRW66	
159mm Drawer Frontal	300mm	KDWDF3	
	400mm	KDWDF4	
	450mm	KDWDF45	
	500mm	KDWDF5	
	600mm	KDWDF6	
	800mm	KDWDF8	
	900mm	KDWDF9	
	1000mm	KDWDF10	
183mm Drawer Frontal	400mm	KDWPF4	
	500mm	KDWPF5	
	600mm	KDWPF6	
557mm Drawer Line	300mm	KDRDL3	
	400mm	KDRDL4	
	450mm	KDRDL45	
	500mm	KDRDL5	
	600mm	KDRDL6	
	800mm	KDRDL8	
	900mm	KDRDL9	
	1000mm	KDRDL10	
	276mm Three Pan Drawer Cabinet Frontal	500mm	KDWDPF5
		600mm	KDWDPF3
800mm		KDWDPF83	
900mm		KDWDPF93	
1000mm		KDWDPF103	
358mm Two Pan Drawer and Bi-fold Bottom Frontal	500mm	KDROCH536B	
	600mm	KDROCH636B	
	800mm	KDROCH836B	
	900mm	KDROCH936B	

	Size	Code
557mm Oven and Integrated Appliance Cabinet Frontal	47mm	KFAAH4
	72mm	KFAAH7
	120mm	KFAAHB
	296mm	KDWDPF6
	450mm	KDRAH
	560mm	KDRDL6
	720mm	KDRFH6
	930mm	KDRIF609
	1018mm	KDRIF610
	1108mm	KDRIF611
	1228mm	KDRIF612
296mm Bridging Cabinet Frontal	600mm	KDROCH63
276mm Bridging Cabinet Frontal	1000mm	KDROCH1028
358mm Bi-fold Cabinet Top Frontal and Bridging Cabinet Frontal	500mm	KDROCH536T
	600mm	KDROCH636T
	800mm	KDROCH836T
	900mm	KDROCH936T
720mm Glazed Wall Cabinet Frontal See page 19 for glazed frontal availability.	400mm	KDRGW3
	500mm	KDRGW2
896mm Glazed Wall Cabinet Frontal See page 19 for glazed frontal availability.	500mm	KDRGW6
1025mm Glazed Dresser Cabinet Frontal See page 19 for glazed frontal availability.	500mm	KDRWD2
720mm Metallic Framed Glazed Frontal	400mm	KDRGW3SL
	500mm	KDRGW2SL

Drawer Box (Revo)	
Code	Description
DWBOTM8P35S*	800mm Deep Pan Drawer Bottom – Pack of three
METAL1BOX8DP*	800mm Three Sided Drawer Box
DWBOTM8P1*	800mm Drawer Box Bottom
METAL1BOX95S*	900mm Pan Drawer Kit
DWBOTM9P15S*	900mm Drawer Box Bottom
METAL3BOX15S*	1000mm Pan Drawer Kit – Pack of three
DWBOTM10P35S*	1000mm Drawer Box Bottom – Pack of three
RPDCONGA473	Pan Drawer Conversion Kit

\*Order drawer kit and drawer bottom to make up full drawer boxes.

Drawer Box (Supra - 15mm Vista)	
Code	Description
SUPRA3BOX15	300mm Drawer Box
SUPRA4BOX15	400mm Drawer Box
SUPRA45BOX15	450mm Drawer Box
SUPRA5BOX15	500mm Drawer Box
SUPRA6BOX15	600mm Drawer Box

Drawer Box (Supra - 18mm Vista)	
Code	Description
SUPRA3BOX18	300mm Drawer Box
SUPRA4BOX18	400mm Drawer Box
SUPRA45BOX18	450mm Drawer Box
SUPRA5BOX18	500mm Drawer Box
SUPRA6BOX18	600mm Drawer Box

# CABINET ELEVATIONS

## 2100mm Cabinet Elevations - Contemporary style example

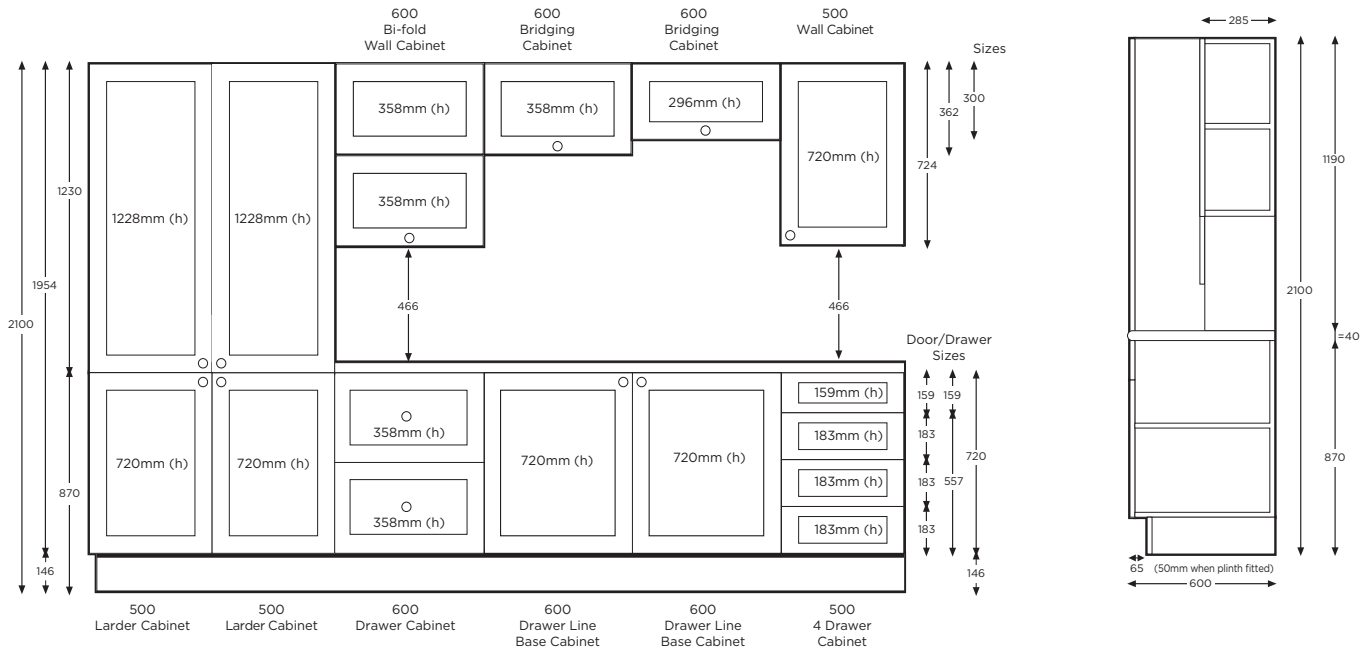

**NB:** Base cabinet height to underside of worktop is 870mm. Actual base cabinet depth is 470mm or 570mm (500mm or 600mm with worktop). Actual wall cabinet depth is 285mm.

## 2276mm Cabinet Elevations - Classic style example

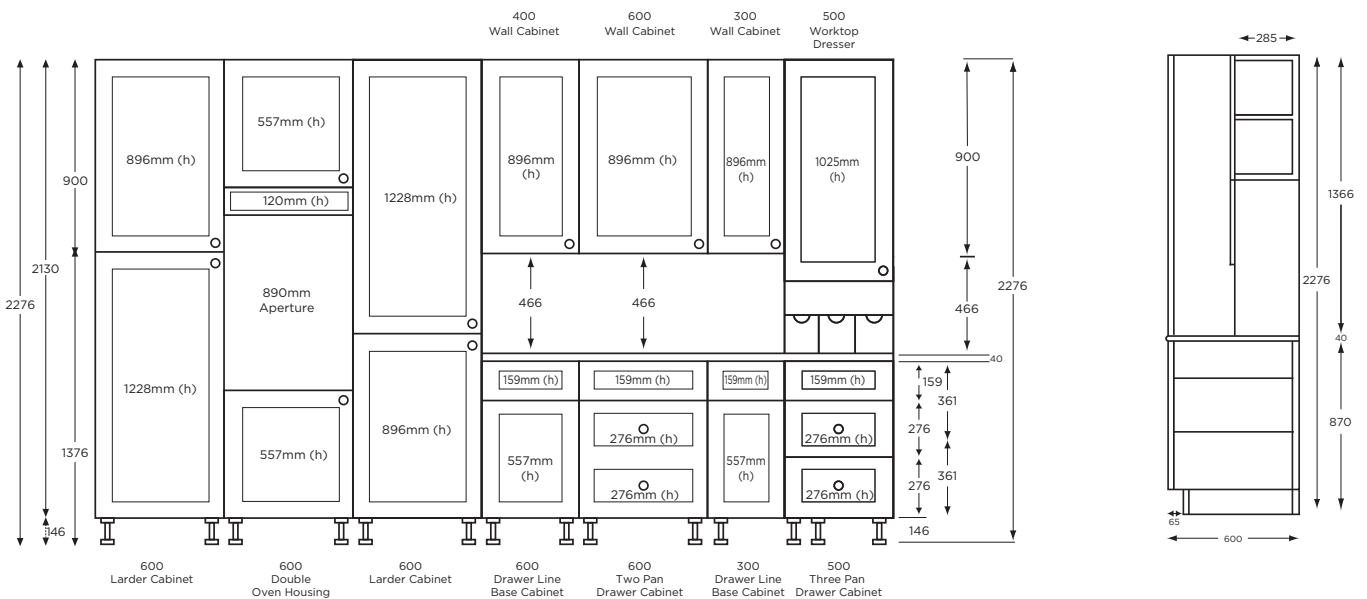

**NB:** Base cabinet height to underside of worktop is 870mm. Actual base cabinet depth is 570mm (600mm with worktop). Actual wall cabinet depth is 285mm.

# 15MM VISTA CABINET INSTALLATION

## WALL UNITS

Screw through the top and bottom back rails/hardboard back. Fixing points in the bottom rail should be vertically in line with those in the top rail.

Fixing points should be located at each end of the unit as shown, no more than 100mm from the inside face of the unit.

Wall units with two doors may require a further fixing at the mid point of the top rail.

Any screws and other fixings used must be suitable to support units, when loaded, into the material to which they are to be fitted.

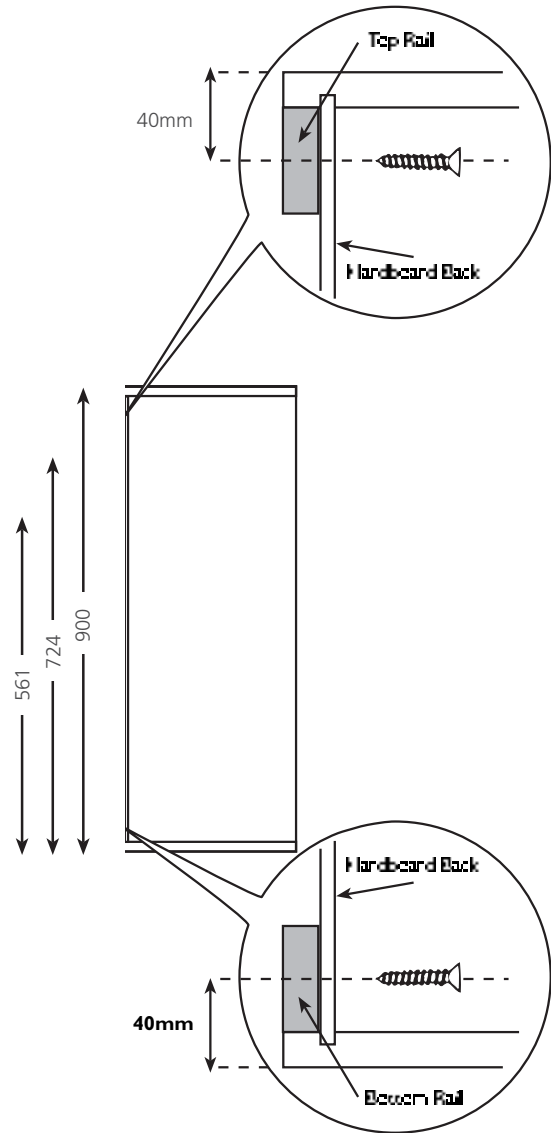

## BASE UNITS

Brackets are secured to the side panel of the unit and screwed through to the wall. Legs can be adjusted as required.

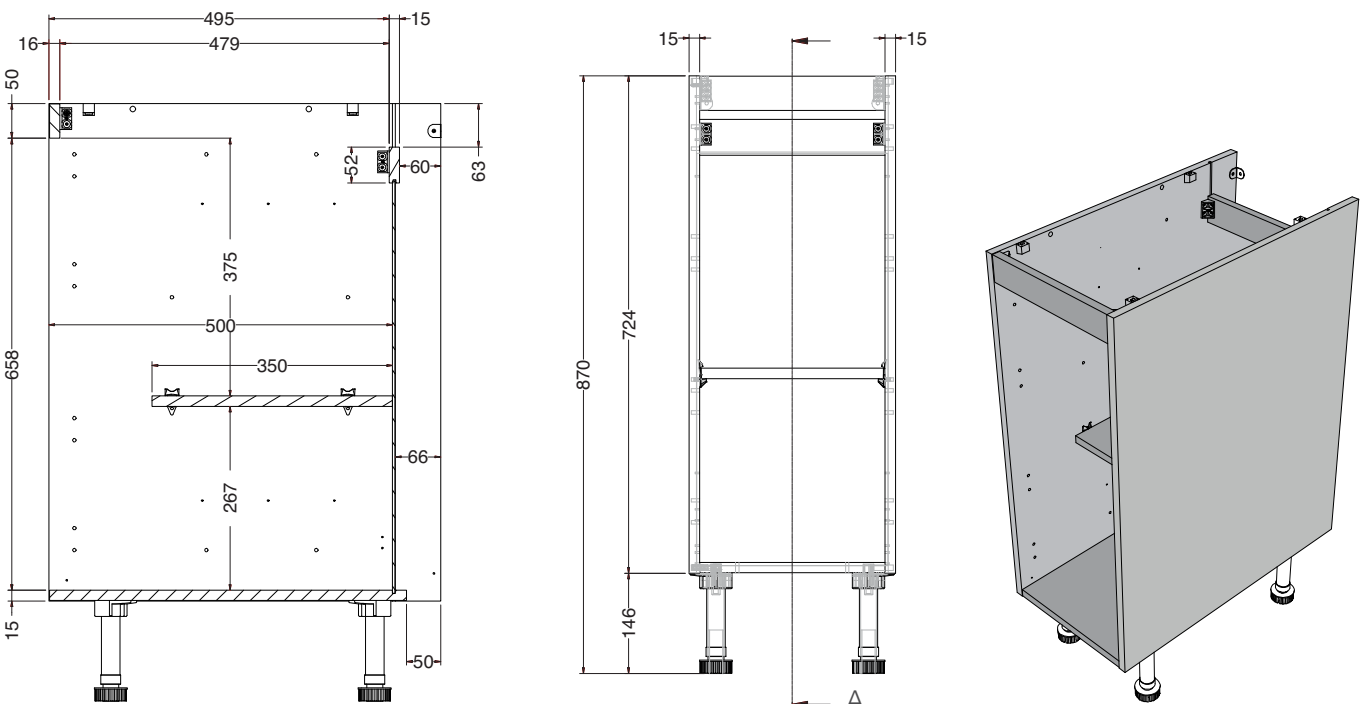

# 18MM EXCEL CABINET INSTALLATION

## WALL UNITS

Wall units are supplied with wall hanging brackets fitted to the unit. The brackets are adjustable for height and distance from the wall. When fitting the units, attach to the wall the hanging plates and make all adjustments. Remove the unit from the wall and drill through the back and vertical upright as indicated (A). Secure the unit with additional screws to a structural part of the wall. Any screws and other fixings used must be suitable to support units, when loaded, into the material to which they are to be fitted.

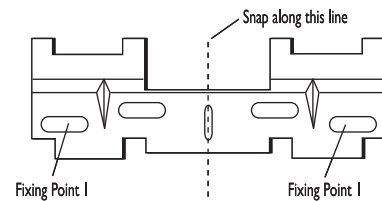
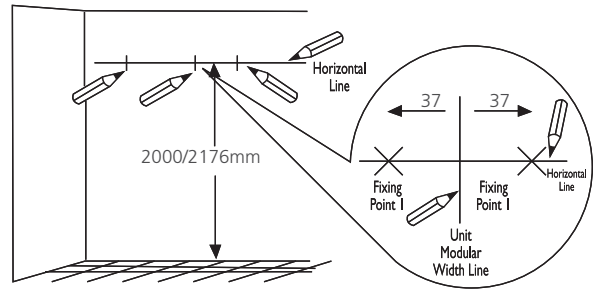
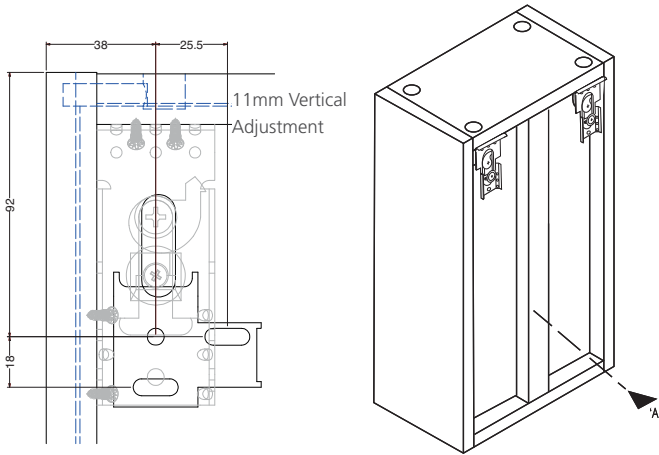

Determine the location of the unit(s) and mark a horizontal line 2176/2000mm from the floor. Mark the position of each unit. Fit the hanging bracket plates to the wall as illustrated.

Fit the hanging brackets to the top corners of the units from the back using four of the screws supplied per bracket. The hanging brackets should be screwed to the side panel first and then to the top panel as per the assembly instructions.

## BASE UNITS

Brackets are secured to the side panel of the unit and screwed through to the wall. Legs can be adjusted as required.

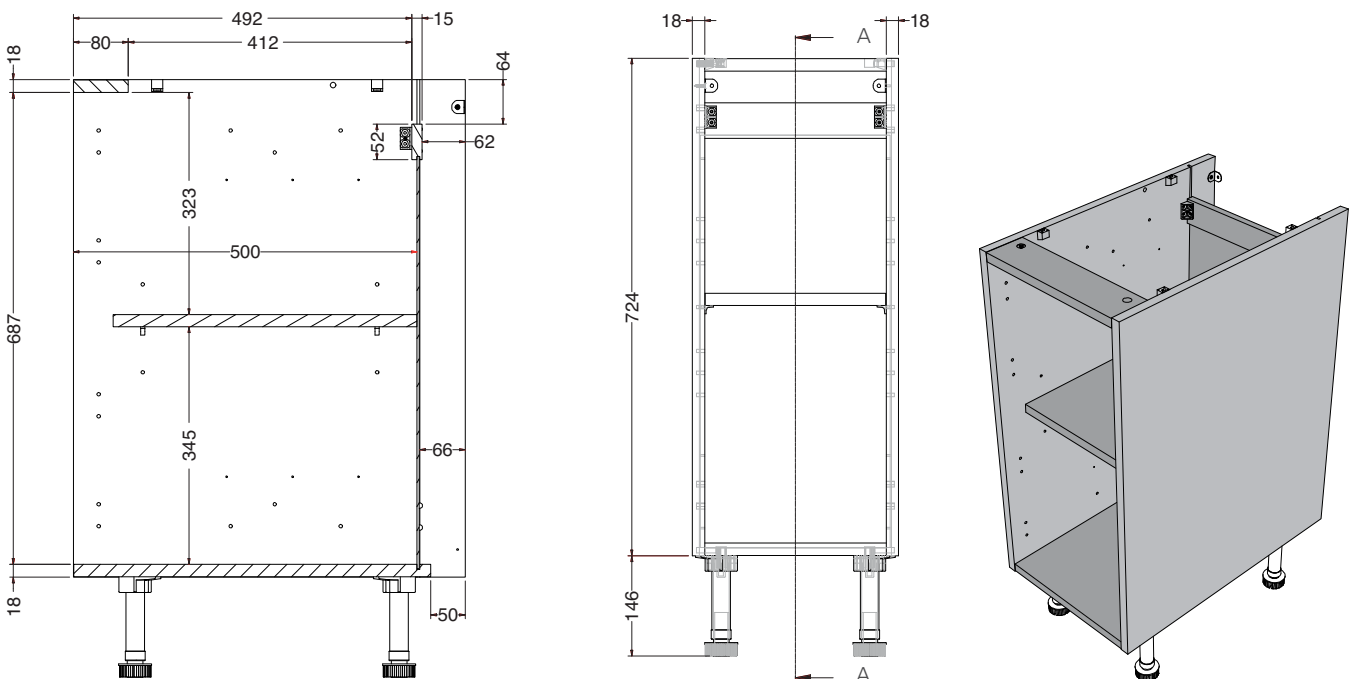

# GUIDANCE NOTES

## For the installation of kitchen fitments (in compliance with BS6222 part 4, 1998)

### DELIVERY AND STORAGE ON SITE

#### ALWAYS:

- Store units, worktops and other items under cover, in dry conditions, immediately.
- Store loose shelves separate from units.
- Protect unit fronts.
- Cover units during storage to prevent dirt and debris collecting on moving parts such as drawer runners and hinges.
- Avoid twisting and distortion.
- Store worktops upright or flat, face to face on bearers with the top surface protected against damage.

#### NEVER:

- Store units on their sides unless they have soft, grit-free material underneath.
- Stack base units more than three high.
- Stack wall units more than four high.
- Stack frontals against each other or against a wall.
- Store units, worktops and other items near direct heat.
- Remove tapes from doors or drawers until immediately before fitting.

Customers must check units as they are delivered and sign for them as being in good condition. If they are not, the driver's copy of the advice note must be marked accordingly and signed by the customer.

### INSTALLATION METHODS

Consideration should be given to following trades when allowing access to electrical points, rodding eyes, stop taps, waste traps and any other items or areas where post completion access will be required.

To prevent any accidental damage to the doors and drawers always remove them from the units and store carefully away from the working area. Any sleeving protection should remain on until they are refitted to the units and adjustment has been carried out.

Having checked the plot for level and square, commence by marking a level line on the wall around the base unit area to indicate the finished unit height.

### FITTING KITCHEN UNITS

Units should be packed up or scribed down as little as possible. We recommend a maximum of 6mm packing with firm material where required.

Scribing down should be 10mm maximum, but this depends on any appliances fitting under worktops. Please check manufacturers appliance sizes before scribing down in excess of 10mm.

If ceramic tiles are to be fitted to the floor after the kitchen has been installed, scribing down of the units will be unnecessary.

Should it be necessary to scribe the rear of the units, then this must be as little as possible especially if integrated appliances are to be fitted into tall units or under worktops.

Kitchen base units should be fixed to the wall using the metal cabinet fixing bracket supplied (18mm Excel). The appropriate fixing should be dependent upon the surface being fixed to. It is not necessary to fix through every bracket on a run of units, but fixings either side of an appliance space and on the ends of each run of units must be made.

Tall units (oven housings, larders, etc.) should be level and plumb on all faces and fixed to the wall at four points.

Wall units are to be fixed level and square using hanging brackets if appropriate, or directly to the wall through the back rail where the following number of fixings should be used:

30072mm to 600mm wide unit 4 fixings

800mm to 1000mm wide unit 5 to 6 fixings

1200mm wide unit 6 fixings

Fixings for standard walls should be 2½" No. 10 counter sunk screws or longer. Dryline walls (dot and dab) will require longer hollow wall fixings, depending on the thickness of the dab and the type of block work being screwed into. It is essential to use the correct fixings and to check screws match the correct plug size being used.

Units should be screwed together at three positions, preferably hidden from view (e.g. by hinge block, back rail on base units and behind shelf on wall units).

All visible screw heads should be capped with colour caps. Recessed caps (10mm) are available for white carcass interiors.

Extended voids (over 600mm wide between end panels) under worktops, especially corner units, and adjacent to worktop joints, should have supporting battens fixed to the wall beneath.

### APPLIANCE SPACES

Care should be taken when leaving spaces for freestanding and integrated built-under appliances.

Built-under integrated spaces should be 603mm maximum. This will allow for easy installation and removal without causing problems with door alignment.

600mm integrated and cantilever cooker hoods require 600mm at the back and front of the void.

Freestanding appliances should have a minimum space 10mm greater than their width to allow easy installation/removal.

Adjacent units to appliance spaces must be plumb and parallel.

Hose positions for dishwasher and washing machines are critical especially on integrated appliances. Dishwasher hoses should be led through an aperture, cut at low level into the side panel at the rear of the adjacent sink unit, for connection to services within that unit. Washer hoses will have holes drilled at top level in the side panel at the rear of the sink unit if connecting to service in the unit.

When fitting any appliances the manufacturer's installation instructions must always be read prior to any installation and followed throughout.

When fitting 'wet' appliances ensure that hoses do not become kinked or trapped when the appliance is pushed home.

### FILLERS

Filler panels are to be scribed to walls and sealed with matching decorator's filler and not silicone.

15mm or smaller fillers where seen, should be edged in exterior cabinet matching colour.

Tray spaces or any site constructed platforms should have the front edges to match the cabinet colour exterior.

### PLINTH

Continuous plinth will be cut and edged at the unit run ends to finish flush with the cabinet end panel. Cabinet exterior matching edging tape should be applied to the raw coreboard with contact adhesive. Peel and stick edging or hot melt adhesive is not recommended.

Ventilation slots as found cut on standard transit plinths on kitchen units must be cut in the continuous plinth for oven, fridge or freezer housings. The slot is approximately 500mm long and 40mm deep and must be cut on the upper edge of the plinth.

Plinths should be fitted tight to the underside of the bottom panel of the base unit and not pushed to the floor. The plinth adds additional support to the bottom panel by keeping it up tight.

Plinths should never be glued or nailed to cabinets as this prevents easy removal.



# GUIDANCE NOTES

## For the installation of kitchen fitments (in compliance with BS6222 part 4, 1998)

### CORNICE AND PELMET

Cornice and light pelmet mitres should be clean and accurately cut using a fine mitre saw.

Fixing cornice should be from above. If this is impossible, fixing from the inside of the cabinet is recommended. When fixing from the inside of the cabinet, 10mm recessed screw caps should be used and 1" x No. 6 CS screw. If longer screws are used and not recessed they should be covered by a matching cover cap.

Light pelmet can be fixed direct through the wall unit bottom or with half blocks/L brackets. A mixture of both methods of fixing is acceptable especially when fixing to display feature units.

All mitres should be glued using PVA wood glue or Cyanoacrylate adhesive. Under no circumstances must hot melt adhesive be used.

Only minor discrepancies in the cut should be filled with matching filler waxes, (not silicone).

Direct fixing should be positioned as close to the end panels as possible for both pelmet and cornice. The number of fixings per unit size are as follows:

300mm to 600mm wide unit	2 fixings
800mm to 1000mm wide unit	3 fixings

The third fixing for 800/1200 units to be by the centre post.

Cornice should be inset on all wall unit/tall unit returns so that the front lip of the flat (fixing) base of the cornice is inset by 15mm, but fitted with the front edge of the unit's top panel on the elevation.

Pelmet should be inset by 15mm on wall unit returns but flush with the front edge of the bottom shelf on the elevation. In this way the appearance of a uniform recess will be achieved when the unit door is closed.

### WORKTOP FIXING

Worktops should be fixed to the base units and independent tops to wall battens, and levelled in both directions.

The tops are fixed through the brackets or half blocks on the base unit end panels, and up through the front rail.

The fixings in the front rail should be as close to the end panel as possible and by the centre post on a double base or corner unit.

Mason Mitre and butt joints should be flush fitted. And three jointing bolts need to be used on all kitchen worktops unless they are reduced in depth or width. A coat of silicone\* should be used to seal the worktop ends prior to jointing.

If the back of the worktop has been scribed to the wall it should then be re sealed with silicone\* before installation. Take special care if sealing behind a sink.

Hob and sink cut outs should also be sealed with silicone\* and the chipboard should be cut and the dust then cleared away. Then silicone\* should be applied to ensure all holes are filled.

\*It is recommended that BS EN150 11600 Silicone to BS5889(B) be used in all cases.

### AFTERCARE INSTRUCTIONS

- The tape from all doors and drawers should be removed by hand, without the use of a sharp implement.
- Any marks subsequently left should be cleaned off using warm water and a mild detergent.
- DO NOT attempt to clean units, worktops or sink tops with cleaning powder or any form of abrasive material or agent.
- Drawer runners and hinges should be cleaned to ensure that no plaster, grit or other material will impede their action.

# CARE FOR YOUR SYMPHONY KITCHEN

---

## We set standards of quality to which others can only aspire

At Symphony, our commitment to quality is total. From our choice of raw materials, right through to the design, manufacture and installation of our products. What's more, every stage of our operation is constantly monitored to ensure that standards are not only maintained but also continuously improved.

In fact, our whole philosophy is one of providing not only the very best products to customers but also complete peace of mind.

### YOUR SYMPHONY KITCHEN CABINET

Symphony kitchens are manufactured from high density, fine surface particle board, which complies with the British Standard BS EN 312-P2. You can be assured that all cabinets are tested to and pass FIRA Gold product certification. Cabinets are supplied on adjustable legs to cater for uneven floors and to protect against moisture ingress. Vulnerable cabinet edges are lipped to resist moisture seepage in to the panels.

### GENERAL CABINET CLEANING ADVICE

Sensible general cleaning practice includes avoiding use of an abrasive cleaner or strong chemicals (such as vinegar, nail varnish remover, solvents and bleach) on surfaces and always wiping off any water with a soft cloth rather than leaving it to stand. It should be noted that cabinets are not resistant to water and will swell if wet, so any spillage should be dried immediately. To clean your cabinets simply use a slightly damp non-abrasive cloth with a little liquid soap.

All Symphony frontals and doors have been made to withstand the normal wear and tear associated with kitchen life and are treated to resist normal household cleaning chemicals. However, any spills should be rinsed immediately and dried thoroughly. Avoid placing electric kettles and steamers directly below wall units and on worktop joints to minimise condensation. Naturally, you should also regularly check that all handle screws are secure and never rest heavy objects on partly opened doors or drawers.

### ADJUSTABLE SHELVES

Unit shelves are adjustable to suit your needs. Whilst units have been FIRA Gold approved and tested to withstand strong weights, we recommend that you load the heaviest items on the base of the cabinet with lighter items on the shelves. It is recommended to evenly distribute items within a cabinet to avoid minor distortion of the unit. Adjustable metal hanging brackets secure wall units to the wall, though we recommend that heavy items are not placed in wall units for both accessibility and safety reasons.

In addition to the specific guidelines detailed in this brochure, you should naturally take extra care when working near to hot surfaces or using cleaning agents. For example, keep all chemicals, detergents, hot pans and sharp objects out of children's reach and never allow them to be unattended in the kitchen and to swing on doors or drawers.

A wide range of base and wall units and colour options are available in flat pack format for ease of storage and quick, easy assembly on site. Please ask your Symphony representative for information.



# CARE FOR YOUR SYMPHONY KITCHEN

---

## CHARACTERISTICS OF VARIOUS TIMBERS

As a natural material, wood reflects the endless variety of grains and textures found in nature and such variances must be expected. All timbers mellow when exposed to sunlight so a colour change is possible overtime. Whilst such definitive characteristics make them a perfect vehicle for furniture design, it is important that they are treated with care. The risk of contact with sharp or heavy objects, scratching, exposure to chemicals, etc. must be avoided before, during and after installation.



### OAK (OAKHAM)

Oak is a finely grained, mature timber notable for its stability and straight graining. Because it can be used for a variety of styles and stained in a number of different colours, it is the traditional favourite of both craftsmen and, of course, homeowners.

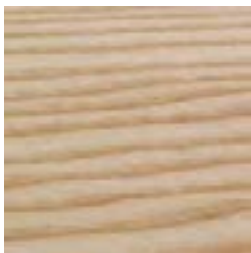

### ASH (AUSTIN)

Ash belongs to the olive tree family and due to its high flexibility it is used in a variety of furniture and flooring products. It is easy to work with and can be stained, waxed or polished very well.

## CABINET/FRONTAL SURFACE CONSISTENCY

Timbers and veneers are natural materials and are subject to the variations in colours and grain differences that nature promotes. All timbers feature small graining marks and knots. These are part of the timber's natural properties and do not represent faults in the door or drawer. It is virtually impossible to guarantee a totally accurate match between timber veneered frontals and accessories. Notwithstanding the difficulties involved, Symphony endeavours wherever possible to produce the closest match that manufacturing and finishing technology allow.

Melamine and laminates are synthetic materials and so have a very stable finish, however they are still liable for changes in colour over time.

## CARE OF YOUR KITCHEN FRONTALS

Doors and drawers should be wiped clean with warm water and a damp cloth containing a mild detergent. For best results, do not over wet. Also, you should avoid the use of scouring pads or wire wool and not use abrasive cleaning agents.

## SOLID TIMBERS AND VENEERS

High quality wood and veneer have been used in the manufacture of all door and drawer fronts. Although the lacquered finish gives a tough hard-wearing surface, spills should be wiped clean immediately and then a wipe over with a damp cloth will restore the finish. Once dry, a final polish with a soft cloth and a reputable household furniture polish will preserve and enhance the wood's natural beauty.

# MINOR ADJUSTMENTS

Because your kitchen doors and drawers will be in constant use, they may require adjustment from time to time to ensure perfect working order. This can be done easily with a simple screwdriver, a brush and some lubricating oil.

## DOOR HINGES AND DRAWER RUNNERS

It's a good idea to inspect the door hinges and drawer runners from time to time so that any dirt, fluff or general grime can be removed.

This can be done with a soft, dry brush or a duster, or even the nozzle of a vacuum cleaner. Although lubrication is usually not required a small amount of household spray polish may be used.



## ADJUSTING THE DOOR

**SIDE ADJUSTMENT**

The side adjustment is made by rotating the appropriate screw on the hinge arm.

**HEIGHT ADJUSTMENT**

For height adjustment the two mounting plate fixing screws have to be temporarily released while making the manual adjustment.

**DEPTH ADJUSTMENT**

The depth adjustment is made by temporarily releasing the adjustment/fixing screw. After the adjustment is made the screw has to be re-tightened.

**SOFT CLOSE ADJUSTMENT**

Where fitted soft close clip on buffers can be adjusted by rotating the screw at the end of the buffer. Please note that soft close buffers are not supplied with every kitchen.

## ADJUSTING THE DRAWER FRONTS

**SUPRA CREAM DRAWER BOX**

Adjust the drawer frontal height by rotating the lever clockwise/anti-clockwise.

**REVO SILVER DRAWER BOX**

To adjust the drawer front vertically clip off the cap, rotate the grooved wheel clockwise/anti-clockwise.

To adjust the drawer front horizontally, rotate the screw clockwise/anti-clockwise.

# WORKTOPS AND SURFACES

---

## GENERAL MAINTENANCE

All Symphony laminate worktop surfaces are designed for easy maintenance and long life. Everyday stains such as coffee spills and finger marks clean up easily with a quick wipe with a damp cloth. Although laminates are exceptionally resistant to scratches and normal wear and tear, always use a cutting board when using sharp knives.

## CLEANING STAINS

Always start with the gentlest method. If stains persist, try the following steps:

- 1 Use a damp cloth and mild detergent.
- 2 For difficult stains, use a mild household cleaner with a soft bristled brush.
- 3 If stubborn stains remain, try a paste of baking soda or a non-scratch cleaner such as Jif or Flash, scrubbing lightly with a soft bristled brush.
- 4 Apply undiluted household bleach, let stand for no more than two minutes and then rinse thoroughly with warm water.

## DO'S AND DON'TS

Never place hot pans or dishes directly onto the worktops. Instead, use a heat shield, hot pad or trivet to avoid blistering or cracking the laminate. Never use acidic or abrasive cleaners, or apply excessive scrubbing, especially on surfaces with a gloss finish.

## EARTHSTONE WORK SURFACES

Through a simple cleaning regime the unique surface can be maintained to look good longer and has the added benefit of being repairable.

You will have received a care and maintenance kit with your Earthstone worksurface along with a leaflet to explain how you can keep your worktop in a good condition.

Once installed your worktop will have been given a final sand and polish. Over time the worksurface will eventually acquire a smoother, slightly higher sheen to it.

## DAILY CLEANING

It is recommended to wipe down the surface with warm soapy water during the first week of installation. Then buff the surface dry and apply a thin, even coat of Countertop Magic (included in your Care and Maintenance kit) and wipe off immediately with clean microfibre cloth.

## WEEKLY POLISH

It is recommended to polish your Earthstone worksurface once a week to maintain its deep, rich lustre. Use the Earthstone Care and Maintenance kit and refer to the leaflet for information on how to do this.

## RECOMMENDATIONS

- Do protect your worksurface from heat damage by using heat resistant mats
- Do wipe spills away quickly
- Do follow the weekly cleaning regime
- Don't place hot objects directly onto the worksurface
- Don't cut directly onto the worksurface
- Don't use abrasive cleaners or solvents as cleaning fluids
- Don't drop heavy objects onto the worksurface

**Please note:** Darker colours will show excessive marking, scratching, wear and tear more noticeably than lighter colours.



# ORDERING CHECKLIST - CHECK THE BOXES TO SPECIFY YOUR CHOICES AS YOU READ THROUGH THE BROCHURE

**1 IDENTIFY YOUR CABINET TYPE** Choose from either  
 15mm Vista (white interior) or  18mm Excel (interior matches the exterior colour)

**2 IDENTIFY AND SPECIFY YOUR DRAWER** Choose from either  
 Supra drawer box (cream) or  Softplus Supra drawer box (cream) or  Revo drawer box (metallic)

**3 IDENTIFY AND SPECIFY YOUR HINGE** Choose from either  
 110° standard  110° Softplus  170° standard  170° Softplus

**4 IDENTIFY AND SPECIFY YOUR CABINET COLOUR** Choose from either  
 White  Ivory  Oak  Walnut

**5 IDENTIFY AND SPECIFY YOUR DOOR AND DRAWER FRONTAL RANGE AND COLOUR**  
 Example; Cranbrook Ivory

**6 IDENTIFY AND CHOOSE YOUR HANDLE** Provide HPK number and description  
 Example; HPK644 - Matt Nickel Square D Handle

**7 SPECIFY YOUR UNIT SIZE** see the table below  
 Example; for a base unit 500mm wide x 870mm high x 600mm deep  
 Example; for a wall unit 500mm wide x 724mm high x 300mm deep  
 Example; for a tall unit 500mm wide x 2100mm high x 600mm deep

**8 SPECIFY YOUR UNIT CODE** see the table below  
 Example; BU56F

**9 IF DESIRED SPECIFY A REPLACEMENT END** see the table below  
 Example; BU56FG2

**10 SPECIFY YOUR UNIT HANDING WHERE REQUIRED** see the table below  
 Example; for a single hinged unit specify left hand or right hand hinged  
 Example; for a corner base specify left hand or right hand blank  
 Example; for a double sink unit specify a left hand or right hand drainer

7 Width	7 Height	7 Depth	8 Code	9 Replacement Ends (If required)	10 Handing (If required)
e.g; 500mm	e.g; 870mm	e.g; 600mm	e.g; BU56F	e.g; G2	e.g; LH

**11 REMEMBER TO ORDER PLINTHS AND ACCESSORIES**

Item	Code	Dimensions
e.g; Plinth	e.g; CONPLINTHF	e.g; 2600 x 146

**12 IDENTIFY AND SPECIFY WORKTOPS** if required.

Code	Style/Colour	Thickness	Length	Depth
e.g; PV40	e.g; Riverside Grey	e.g; 40mm	e.g; 2000mm	e.g; 600mm



Gallery



LAURA ASHLEY  
by Symphony



Dibben Kitchens - [adunits@dibbenkitchens.co.uk](mailto:adunits@dibbenkitchens.co.uk) - 0800 8527780